

Longse Product Catalogue 2020

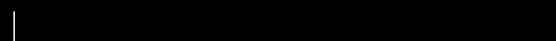

PRODUCT CATALOGUE

Distributed By

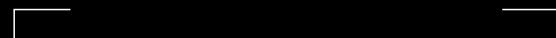

Longse Technology Co., Ltd.

E-mail: info@longse.com Web: www.longse.com Tel: +86 20-66217333 Fax: +86 20-66217338

Copyright©2020 Longse Technology Co., Ltd. All rights reserved.
Disclaimer: Longse Technology reserves the rights to design changes due to improved products, without further notice.
Longse Technology does not accept the consequence resulted from any error as all information is carefully checked to be accurate

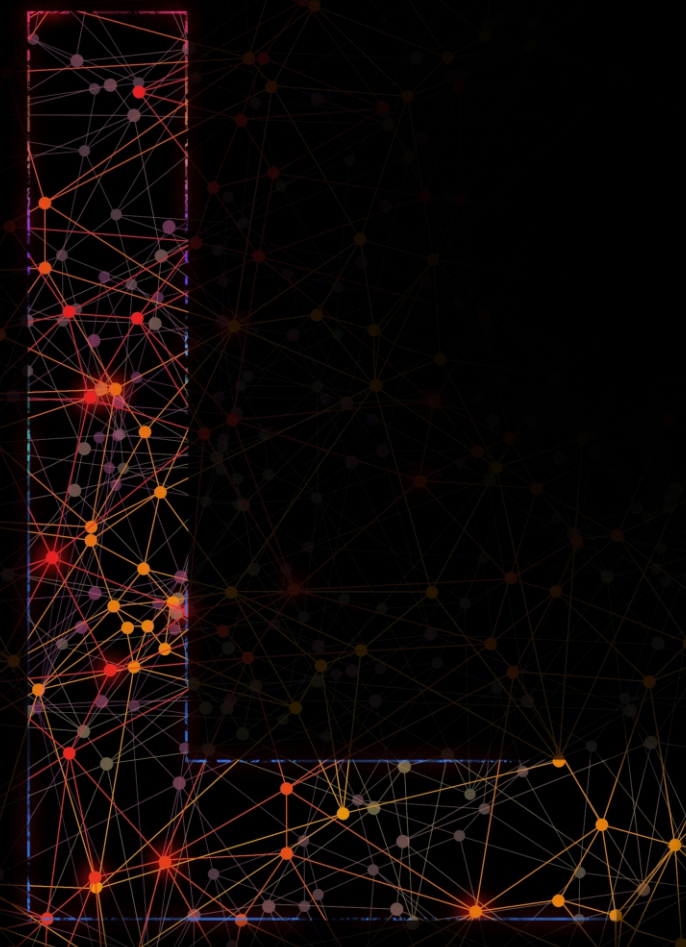



Company Profile

Longse Technology Co., Ltd. was founded in 2006, is a professional IOT (Internet of Things) solution provider with video as the core, providing security, visual management and big data service for the world. We uphold the values of dedication, integrity, innovation and excellence, aspiring to become a first-class national enterprise and world-class enterprise.



Mission

More secure, More intelligent



Vision

Become a first-class national enterprise and world-class enterprise



Core Values

Dedication, Integrity, Innovation, Excellence



Location

An IOT (Internet of Things) solution provider with video as the core, providing security, visual management and big data service for the world

■ Model Code Description	01
■ Surveillance Cameras	02-18
- Camera Features	03-04
- Motor Zoom Description	05
- Specification Sheets	06-09
- Fisheye Camera	10
- Bullet Camera	11-13
- Dome Camera	14-16
- Other Camera	16-18
■ PTZ Speed Dome Camera	19-26
■ XVR & NVR & SDI DVR	27-42
- XVR/NVR/SDI DVR Features	28
- XVR/NVR/SDI DVR Description	29-30
- PoE NVR	31-32
- NVR	33-34
- WIFI NVR	35
- XVR	36-41
- SDI DVR	42
■ DIY Kits	43-57
- Wireless Kits	44-50
- POE NVR Kits	51-52
- XVR Kits	53-57
■ CCTV Accessories	58-60

What's the item code's meaning?

Bullet Camera

LBH30SP200

Brand longse
 Bullet
 IR leds quantity
 Code for different housing
 Code for different solution



Dome Camera



LIRDCAHTC200ESP

Brand longse
 IR camera
 Dome
 Code for different housing
 Code for different solution

PTZ Speed Dome

PT5A018

PTZ, pan, tilt, zoom
 Dome's diameter. 6 means 6", 4 means 4.5" inch, 7 means 7 inch
 Zoom times. 22 means 22X, 18 means 18X, 10 means 10X.
 Code for speed. 0 means medium speed, 1 means high speed.
 Code for different housing



XVR



XVRDKA3104DB

5 IN 1 XVR
 AHD/CVI/TVI/CVBS/HD IP
 Solution code
 K stands for 4K HD
 Without K, it means it is not
 A or T stands for chip
 Solution code
 Code for different housing
 Channel quantity

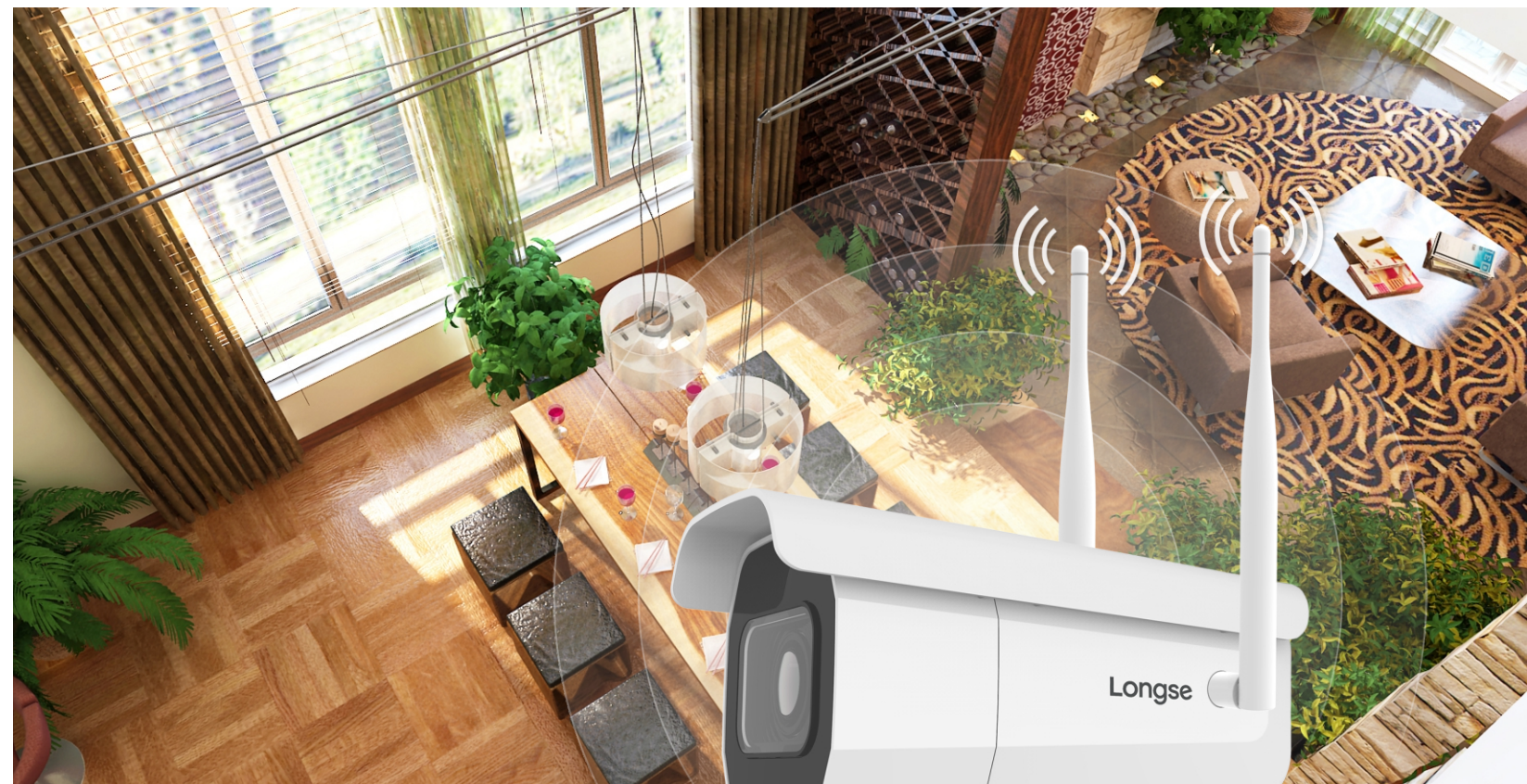

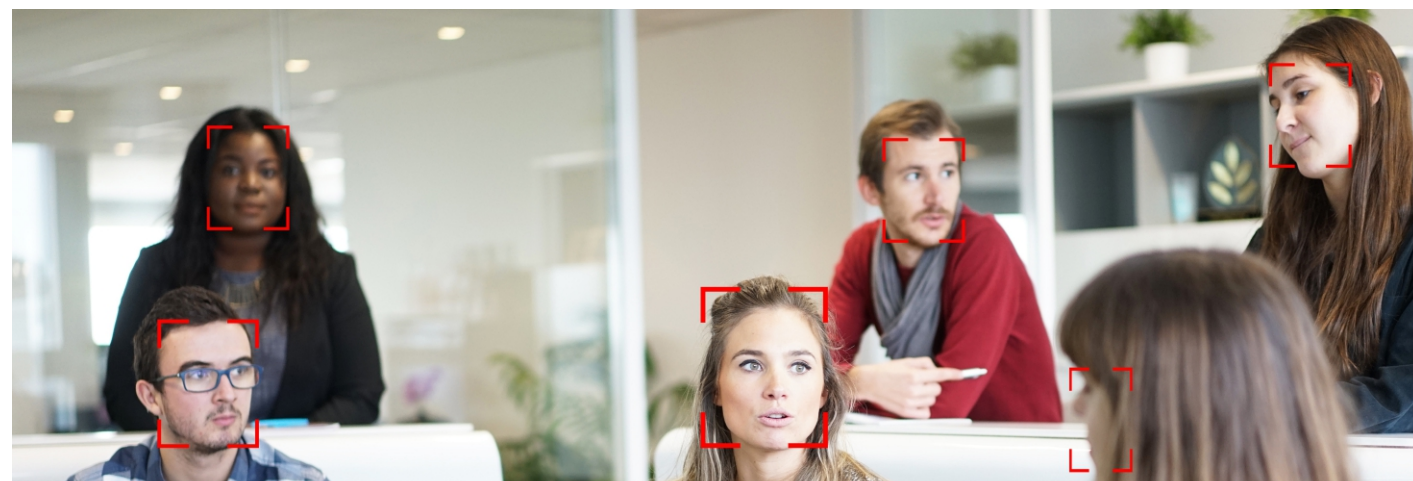

Face Recognition

Face detection refers to detecting and positioning key features of the face, the main face area can be cropped and analyzed according to the facial features, shapes and angles. After pre-processing, feedbacks sent to backend recognition algorithm, comparing with the existing pictures then figure out the user's identity.



Crossover Detection

Crossover detection refers to detecting if someone or something crossing the line that demarcated on the image, it will trigger the alarm.



Loitering Detection

Wandering Detection refers to match and track the targets appearing in the video surveillance area according to the location, and record the existence time and the quantity of presentation of the target. Alarm will be triggered when existence time or quantity of presentation of the target more than the threshold setting value.



Intrusion Detection

Regional intrusion detection refers to detect if someone or something enter the specified monitoring area, it will trigger the alarm when it happens.



People Gather Detection

People Gathering Detection refers to detect and analyze the specific area where people are gather, it will trigger the alarm when crowd density reach or exceed the set point.

1 WDR - Wide Dynamic Range

It produces clear picture quality even under back light condition when there are both very bright and dark area simultaneously.



Conventional

Wide Dynamic Range (WDR)

2 Smart IR

Longse Smart IR technology automatically adjusts IR lighting intensity and ensures that the camera captures usable video in dark conditions, even when the object of interest is located close to the IR LEDs.

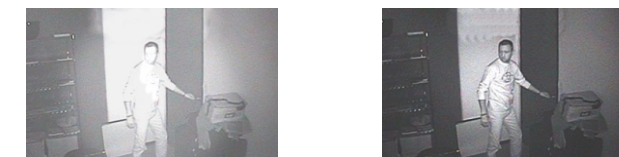

Normal IR Camera

IR Low Illumination

3 HLC (High Light Compensation)

It will mask the source of the bright light with a dark shape, thus allowing the area to the side of the light source to be viewed and recorded. HLM or HLC is the same features.



HLC Off

HLC On

4 Defog / Demist

The defog/demist function uses an advanced algorithm to enhance the images captured in hazy ambient conditions such as fog, mist, harsh, backlighting, or low ambient lighting. This function gives a sharp, clear picture, even in less than ideal conditions.



Demist Off

Demist On

5 Smart NR (3D Noise Reduction)

3DNR Technology (3D Noise Reduction) is a method of suppressing noise in an image, appearing in low light.



3DNR: Off

3DNR: On

6 Sense-Up (Slow Shutter)

See in color-in the dark! By automatically slowing the shutter speed, the camera is able to pick up the slightest traces of light to display a bright image.

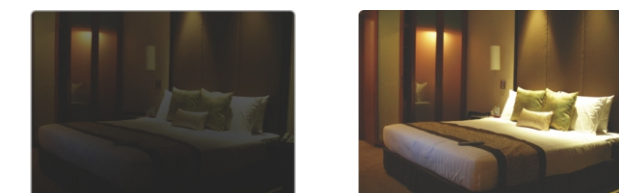

Sense Up: Off

Sense Up: On

7 True Day/Night (IR Cut Filter)

For more accurate, vivid color reproduction during daytime use, an IR Cut filter is automatically moved over the lens to block unwanted IR. At night, the filter is removed to deliver maximum visibility and clear IR illumination.

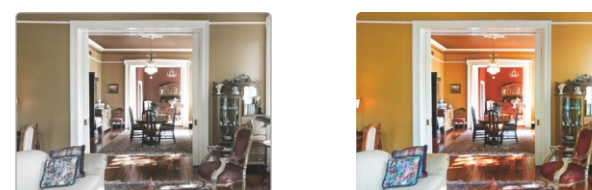

Night

Day

8 Motion Detection

By defining areas of interest – like a door, driveway or window – you can define when the NVR should start recording video. You can schedule recordings, or the NVR can record when there is motion. This not only conserves hard drive space, but also means you can record for more days before older recordings are overwritten.

Motion Detection
Automatic Video / Save Worry



Motor Zoom / Auto Focus

Auto Zoom Description



Motor Zoom + Auto Focus



E-ZOOM

Zoom Lens By XVR

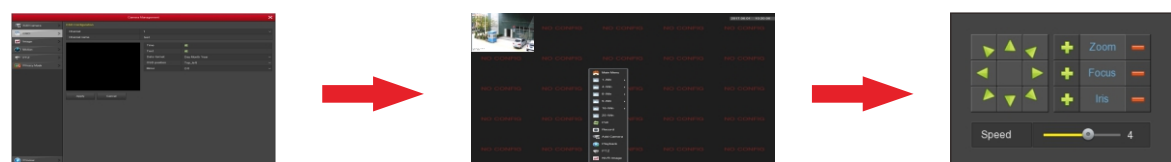

1. Set XVR protocol, baud rate, and ID the same as camera's.

2. Choose channel connected with auto zoom camera. Right click the main screen for quick menu, select "PTZ control".

3. On XVR PTZ interface, click Zoom + and Zoom - for Zoom in and out, and camera has auto focus.

Zoom Lens By Joystick Controller

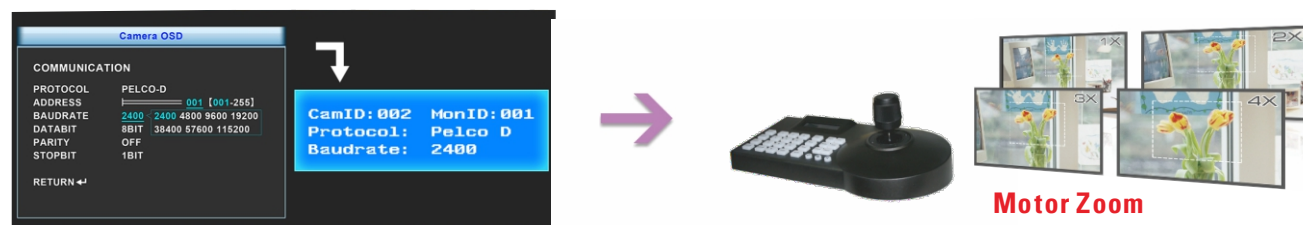

1. Set protocol, baud rate, and ID of keyboard controller the same as camera's.

2. Left or right swing the joystick for zoom in and out, cameras auto focus.

12MP IP Camera Resolutions

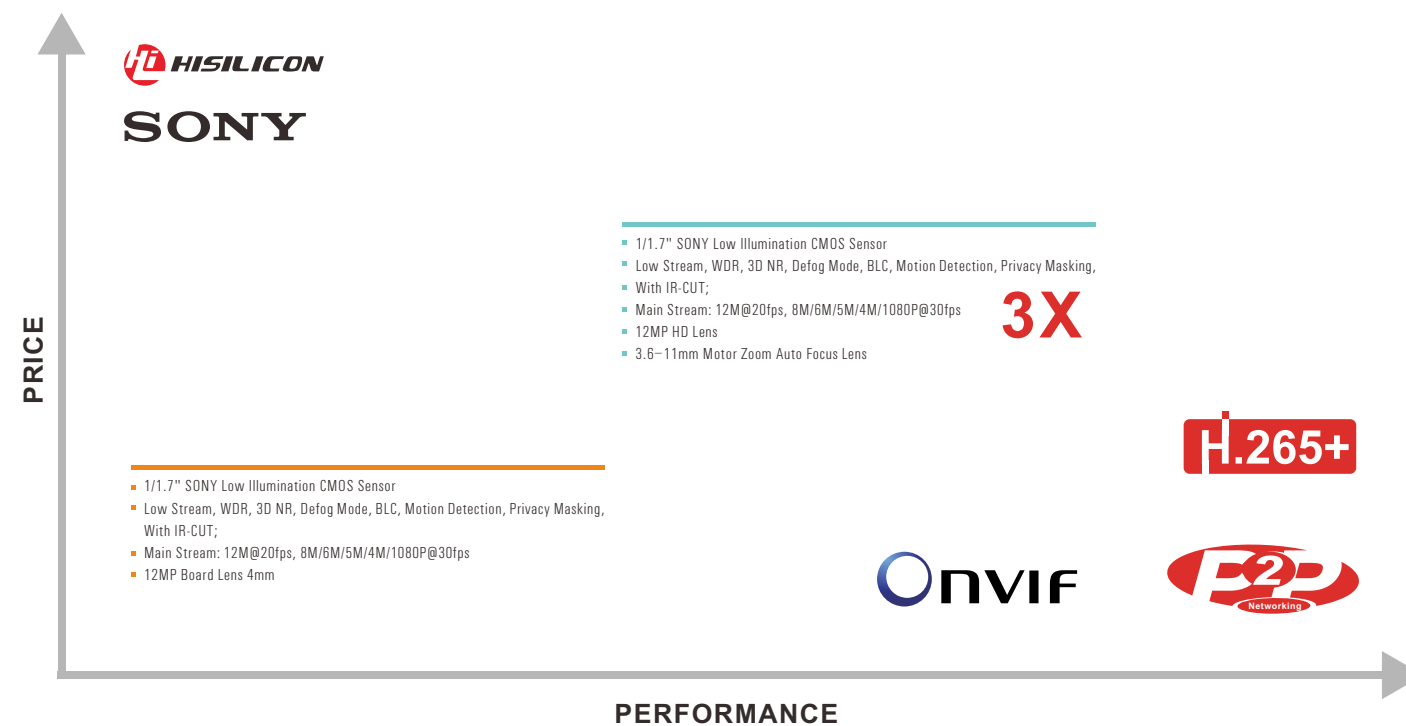

Specification Sheets

8MP IP Camera Resolutions

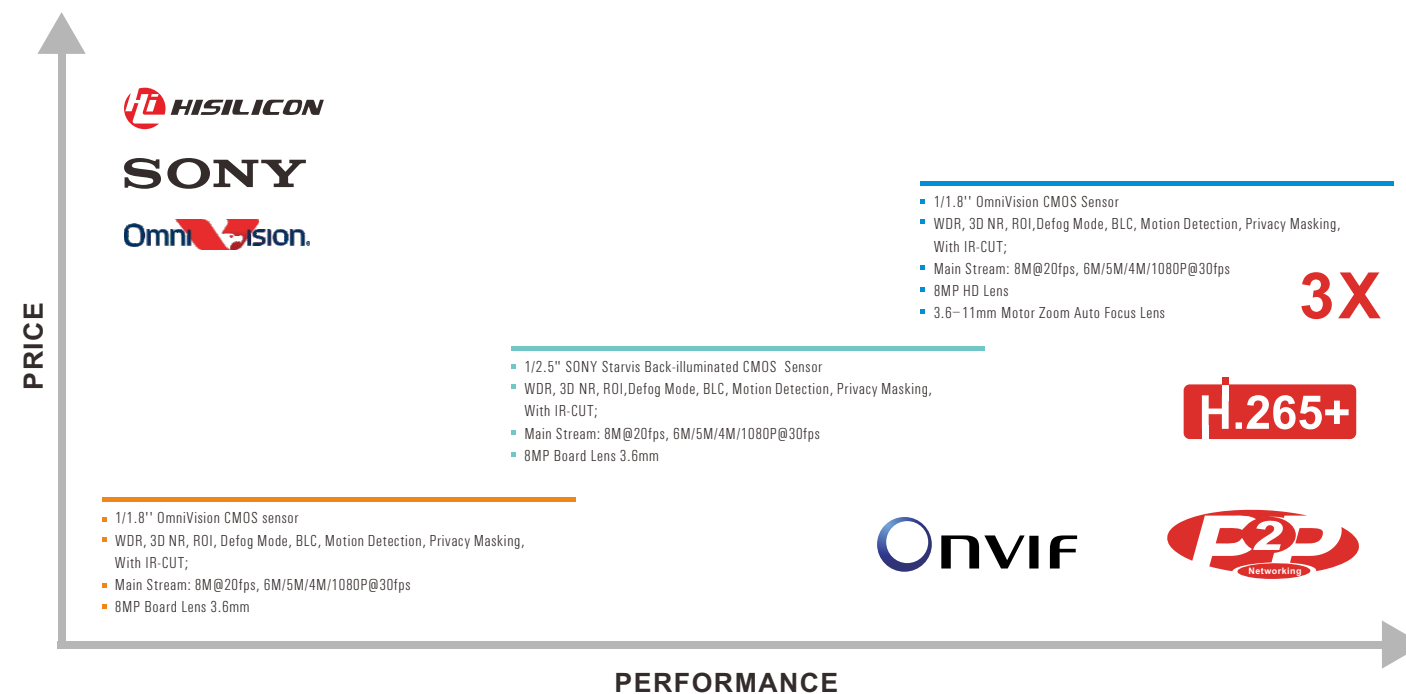

5MP IP Camera Resolutions

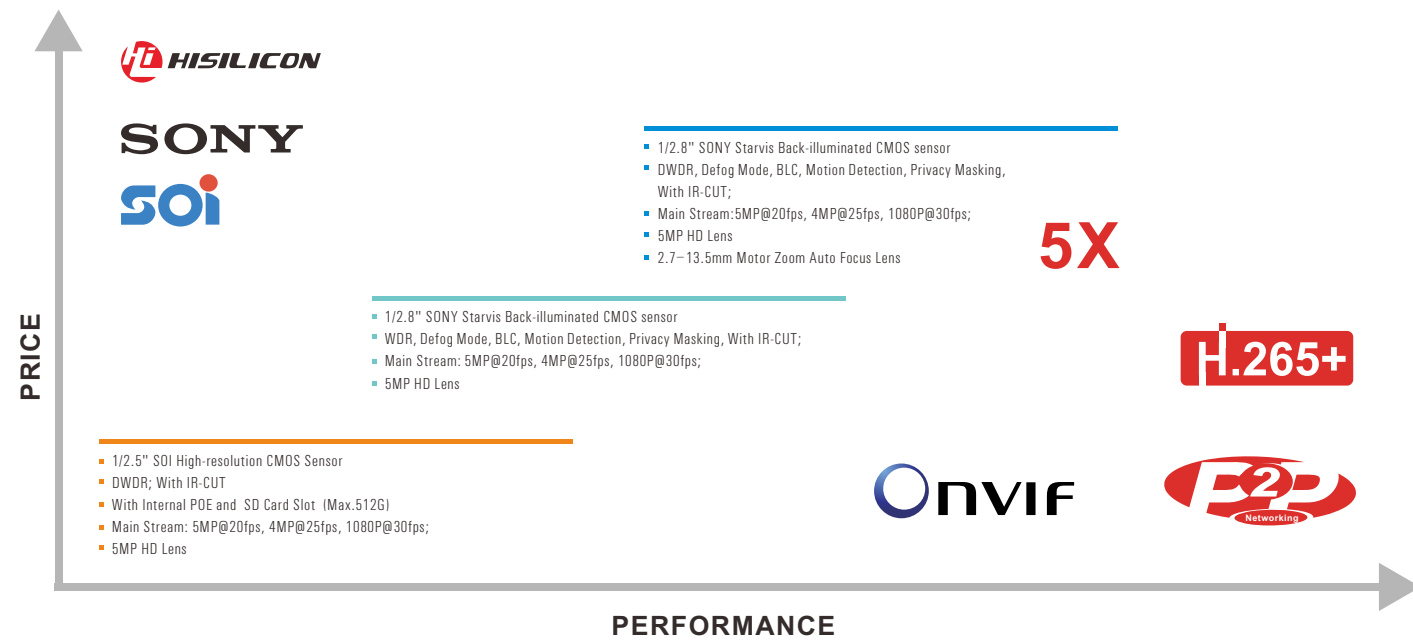

4K HD Camera Resolutions

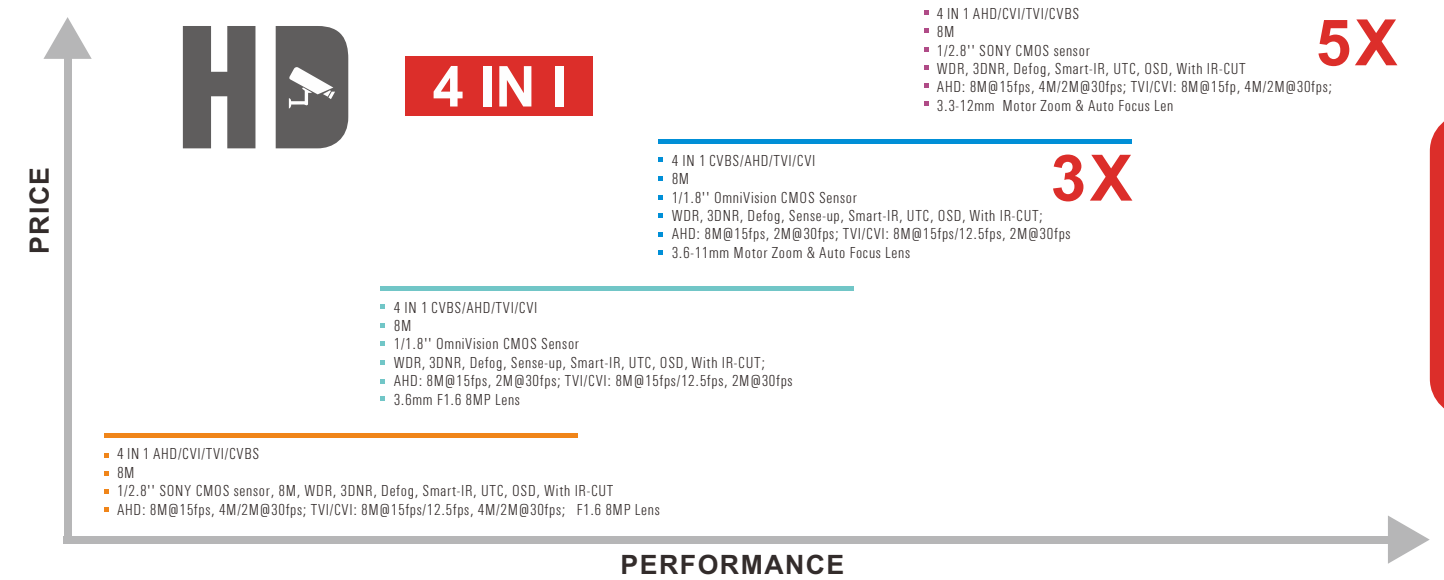

2MP IP Camera Resolutions

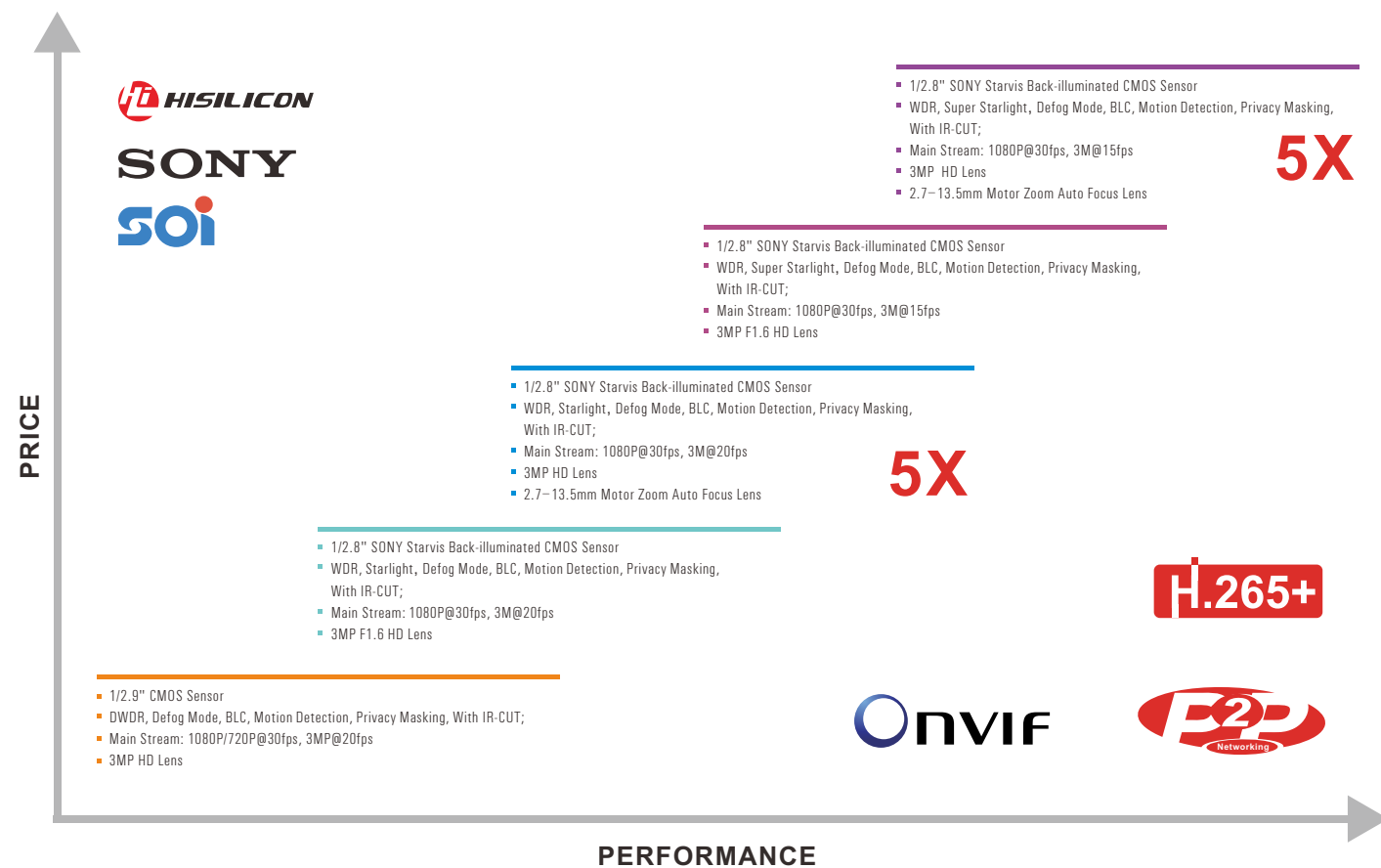

5MP/4K Lite HD Camera Resolutions

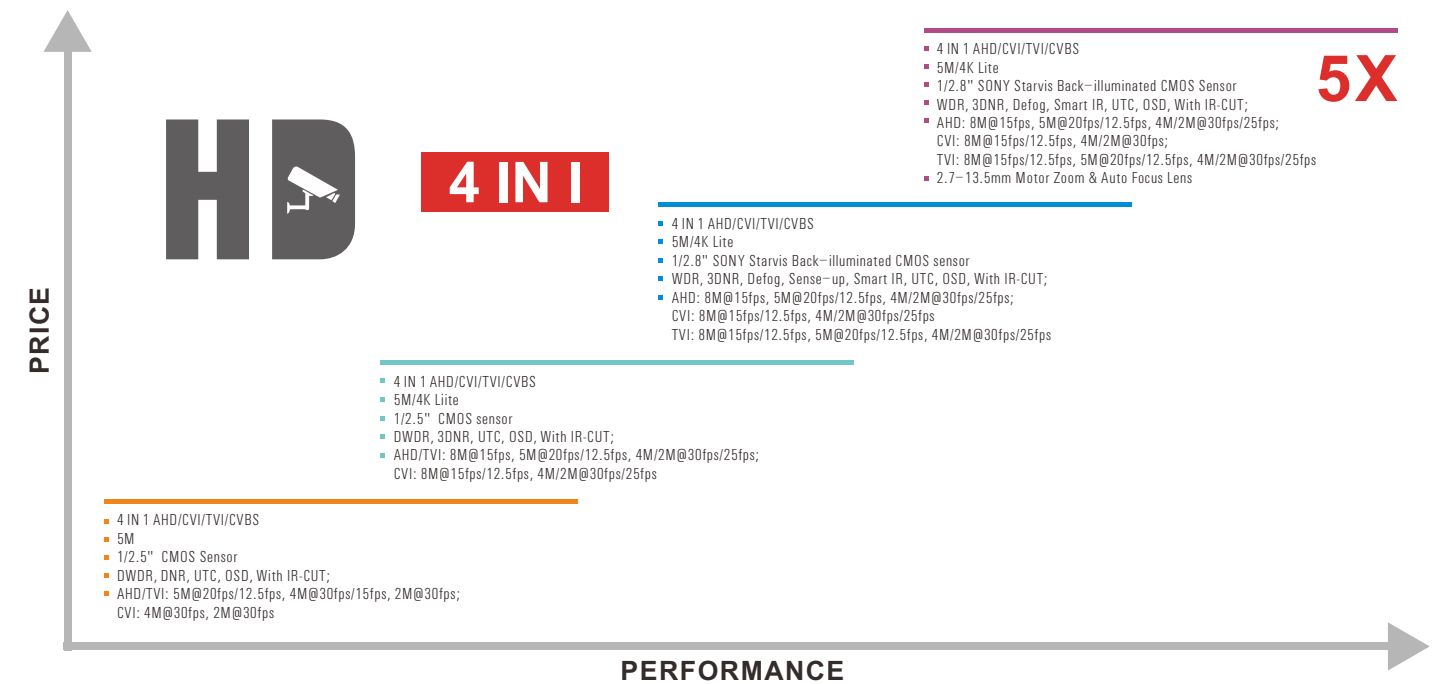

4MP/4K Lite HD Camera Resolutions



2MP/5MP Lite HD Camera Resolutions

Specification Sheets



4 IN 1

6 IN 1

- 6 IN 1 EX-SDI/HD-SDI; CVBS/AHD/TVI/CVI
 - 1080P/960H
 - 1/2.8" SONY Starvis Back-illuminated CMOS Sensor
 - Starlight, WDR, 3DNR, Defog, Sense-up, Smart IR, UTC, OSD, With IR-CUT;
 - 2x BNC Output
 - 2.7-13.5mm Motor Zoom & Auto Focus Lens
- 5X**

- 6 IN 1 EX-SDI/HD-SDI; CVBS/AHD/TVI/CVI
- 1080P/960H
- 1/2.8" SONY Starvis Back-illuminated CMOS Sensor
- Starlight, WDR, 3DNR, Defog, Sense-up, Smart IR, UTC, OSD, With IR-CUT;
- 2x BNC Output
- 2M F1.6 Lens

- 4 IN 1 AHD/CVI/TVI/CVBS
 - 1080P/960H
 - 1/2.8" SONY Starvis Back-illuminated CMOS Sensor
 - Super Starlight, WDR, 3DNR, Defog, Sense-up, Smart IR, UTC, OSD, With IR-CUT;
 - 2.7-13.5mm Motor Zoom & Auto Focus Lens
- 5X**

- 4 IN 1 AHD/CVI/TVI/CVBS
 - 1080P/960H
 - 1/2.8" SONY 2.1MP Starvis Back-illuminated CMOS Sensor
 - Starlight, WDR, 3DNR, Defog, Sense-up, Smart IR, UTC, OSD, With IR-CUT;
 - 2.7-13.5mm Motor Zoom & Auto Focus Lens
- 5X**

- 4 IN 1 AHD/CVI/TVI/CVBS
- 1080P/960H
- 1/2.8" SONY Starvis Back-illuminated CMOS Sensor
- Super Starlight, WDR, 3DNR, Defog, Sense-up, Smart IR, UTC, OSD, With IR-CUT;
- 2MP F1.6 HD Lens

- 4 IN 1 AHD/CVI/TVI/CVBS
- 1080P/960H
- 1/2.8" SONY Starvis Back-illuminated CMOS Sensor
- Starlight, WDR, 3DNR, Defog, Sense-up, Smart IR, UTC, OSD, With IR-CUT;
- 2MP F1.6 HD Lens

- 4 IN 1 AHD/CVI/TVI/CVBS
- 2M/5M Lite
- 1/2.8" SONY Starvis Back-illuminated CMOS Sensor
- DWDR, DNR, UTC, OSD, With IR-CUT;
- AHD/TVI: 5M@20fps/12.5fps, 4M@30fps, 2M@30fps; CVI: 4M@30fps, 2M@30fps

- 4 IN 1 AHD/CVI/TVI/CVBS
- 1/3" CMOS sensor,
- 2MP /5MP
- With IR-CUT, DWDR, DNR, UTC, OSD.
- AHD/TVI: 5M@20fps, 4M@30fps, 2M@30fps; CVI: 4M@30fps, 2M@30fps

- 4 IN 1 AHD/CVI/TVI/CVBS
- 1080P/960H
- 1/3" CMOS Sensor
- DWDR, UTC, OSD, With IR-CUT

PRICE

PERFORMANCE

360° Full View Camera



4MP 12MP



LMDE

Dimensions

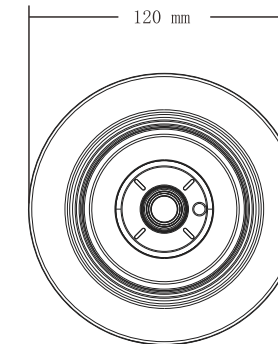
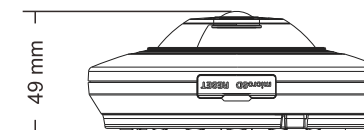

- SD Recording
- Night Vision SMD Led
- 1.05/1.77MM
- Audio In/Out
- Reset

Fisheye Camera

Bitvision & VR Demo



Bitvision

Download Bitvision
With this smarter way to get your security work started!
Check out your places anytime!



Fish-eye Model



Double window spread out

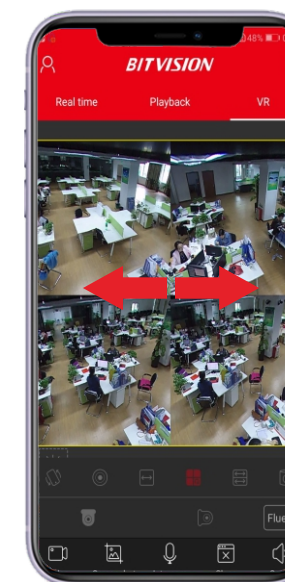

Four-screen Model



Cylinder

Surveillance Cameras

► Bullet Camera



SD PoE Ai

▼ BMSA

IPC	2MP, 5MP
-----	----------

Carton	52*39*28CM
Quantity	30PCS
Color	White
Voltage	DC12V



- Vandalproof & Weatherproof
- Water Resistance: IP67
- IR LED: 42μ x 2PCS
- IR Range: 20M
- Board Lens 3.6mm
- Size: 171(W) x 73(H) x 73(D)mm
- Weight: 650g

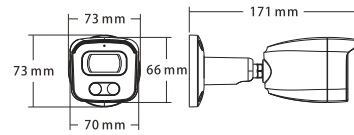

SD PoE Ai

▼ BMMA

IPC	2MP, 5MP
-----	----------

Carton	59*35*49CM
Quantity	8PCS
Color	White
Voltage	DC12V



- IR LED: 42μ x 4PCS, 40M
- Fixed Lens : 3.6mm, 6mm
- Motorized Lens : 2.7-13.5mm, 3.6-11mm
- Water Resistance: IP67
- Size: 179(W) x 90(H) x 90(D)mm
- Weight: 1.4Kgs

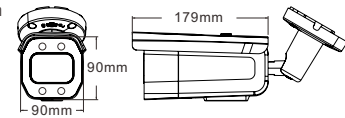

SD PoE Ai

▼ BMLA

IPC	2MP, 5MP
-----	----------

Carton	59*35*49CM
Quantity	10PCS
Color	White
Voltage	DC12V



- Vandalproof & Weatherproof
- Water Resistance: IP67
- IR LED: 42μ x 6PCS
- IR Range: 60M
- Board Lens 6mm
- Size: 220(W) x 105(H) x 109(D)mm
- Weight: 1.65Kgs

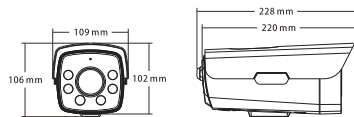

WiFi SD PoE

▼ LBH30

IPC	2MP, 5MP, 6MP
-----	---------------

HD	2MP, 4MP, 5MP Lite, 5MP, 4K lite, 4K
----	--------------------------------------

Carton	52*39*28CM
Quantity	30PCS
Color	White
Voltage	DC12V



- IR LED: 14μ x 20PCS, 25M
- IR LED: 42μ x 2PCS, 30M
- IR LED: 42μ x 4PCS, 40M
- Lens: 2.8mm, 3.6mm
- Water resistance: IP67
- Anti-Cut 3-Axis Bracket
- Size: 157(W) x 70(H) x 66(D)mm
- Weight: 650g

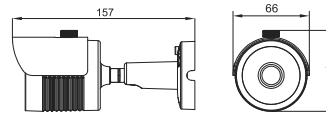

WiFi SD PoE Ai

▼ LBE60

IPC	2MP, 5MP
-----	----------

HD	2MP, 4MP, 5MP Lite, 5MP, 4K lite, 4K
----	--------------------------------------

Carton	59*35*49CM
Quantity	8PCS
Color	White
Voltage	DC12V



- IR LED: 42μ x 4PCS, 40M
- Fixed Lens : 3.6mm, 6mm
- Motorized Lens : 2.7-13.5mm, 3.6-11mm
- Water Resistance: IP67
- Size: 179(W) x 90(H) x 90(D)mm
- Weight: 1.4Kgs

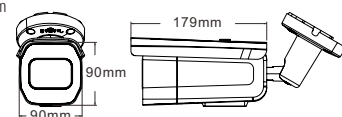

WiFi SD PoE

▼ LBE90

IPC	2MP, 5MP, 8MP, 12MP
-----	---------------------

HD	2MP, 4MP, 5MP Lite, 5MP, 4K lite, 4K
----	--------------------------------------

Carton	59*35*49CM
Quantity	8PCS
Color	White
Voltage	DC12V



- IR LED: 42μ x 6PCS, 60M
- Fixed Lens : 3.6mm, 8mm
- Motorized Lens : 2.7-13.5mm, 3.6-11mm
- Water Resistance: IP67
- Size: 179(W) x 90(H) x 90(D)mm
- Weight: 1.4Kgs

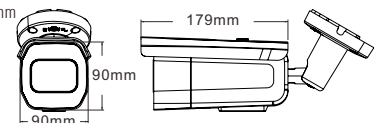

WiFi SD PoE Ai

▼ LBB60

IPC	2MP, 5MP
-----	----------

HD	2MP, 5MP Lite, 5MP, 4K lite, 4K
----	---------------------------------

Carton	59*35*49CM
Quantity	10PCS
Color	White
Voltage	DC12V



- IR LED: 42μ x 4PCS, 40M
- Fixed Lens : 3.6mm, 6mm
- Motorized Lens : 2.7-13.5mm, 3.6-11mm
- Water Resistance: IP67
- Size: 220(W) x 105(H) x 109(D)mm
- Weight: 1.65Kgs

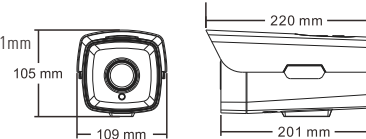

WiFi SD PoE

▼ LBB90

IPC	2MP, 5MP, 8MP, 12MP
-----	---------------------

HD	2MP, 5MP Lite, 5MP, 4K lite, 4K
----	---------------------------------

Carton	59*35*49CM
Quantity	10PCS
Color	White
Voltage	DC12V



- IR LED: 42μ x 6PCS, 60M
- Fixed Lens : 3.6mm, 8mm
- Motorized Lens : 2.7-13.5mm, 3.6-11mm
- Water Resistance: IP67
- Size: 220(W) x 105(H) x 109(D)mm
- Weight: 1.65Kgs

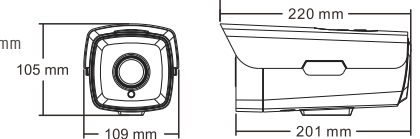

Bullet Camera

WiFi SD PoE Ai

▼ LBF30

IPC	2MP, 5MP, 6MP, 12MP
-----	---------------------

HD	2MP, 4MP, 5MP Lite, 5MP, 4K lite, 4K
----	--------------------------------------

Carton	55*42*42CM
Quantity	25PCS
Color	White
Voltage	DC12V



- IR LED: 14μ x 20PCS, 25M
- IR LED: 42μ x 4PCS, 40M
- Fixed Lens : 3.6mm, 4mm
- Water Resistance: IP67
- Anti-Cut 3-Axis Bracket
- Size: 186(W) x 75(H) x 71(D)mm
- Weight: 500g

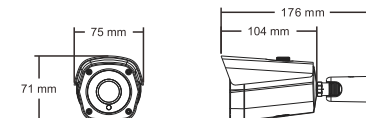

PoE Ai

▼ LBF60

IPC	2MP, 5MP
-----	----------

HD	2MP, 5MP Lite, 5MP, 4K lite, 4K
----	---------------------------------

Carton	54*39*37CM
Quantity	16PCS
Color	White
Voltage	DC12V



- IR LED: 42μ x 4PCS, 40M
- Fixed Lens : 3.6mm, 6mm
- Motorized Lens : 2.7-13.5mm, 3.6-11mm
- Water Resistance: IP67
- Size: 179(W) x 94(H) x 93(D)mm
- Weight: 1.1Kgs

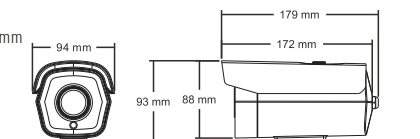

PoE

▼ LBF90

IPC	2MP, 5MP
-----	----------

HD	2MP, 5MP Lite, 5MP, 4K lite, 4K
----	---------------------------------

Carton	54*39*37CM
Quantity	16PCS
Color	White
Voltage	DC12V



- IR LED: 42μ x 6PCS, 60M
- Fixed Lens : 3.6mm, 8mm
- Motorized Lens : 2.7-13.5mm, 3.6-11mm
- Water Resistance: IP67
- Size: 179(W) x 94(H) x 93(D)mm
- Weight: 1.1Kgs

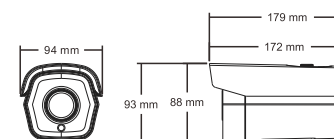

IPC	2MP
-----	-----

HD	2MP, 5MP Lite, 5MP
----	--------------------

Carton	52*39*28CM
Quantity	30PCS
Color	White
Voltage	DC12V



- IR LED: 14μ x 18PCS, 20M
- Fixed Lens : 2.8mm, 3.6mm
- Water resistance: IP67
- Anti-Cut 3-Axis Bracket
- Size: 160.8(W) x 62(H) x 62(D)mm
- Weight: 380g

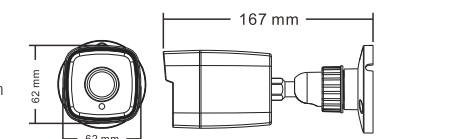

WiFi PSE

IPC 2MP, 5MP

HD 2MP, 4MP, 5MP Lite, 5MP, 4K lite, 4K

Carton	55*42*42CM
Quantity	15PCS
Color	White
Voltage	DC12V

- IR LED: (42μ) x 4pcs, 40M
- Fixed Lens : 3.6mm
- Motorized Lens : 2.8-12mm, 2.7-13.5mm, 3.6-11mm
- Water resistance: IP67
- Anti-Cut 3-Axis Bracket
- Size: 220(W) x 80(H) x 80(D)mm
- Weight: 1.4KG



WiFi PSE

IPC 2MP, 5MP

HD 2MP, 4MP, 5MP Lite, 5MP, 4K lite, 4K

Carton	55*42*42CM
Quantity	15PCS
Color	White
Voltage	DC12V

- IR LED: (42μ) x 6pcs, 60M
- Fixed Lens : 3.6mm
- Motorized Lens : 2.8-12mm, 2.7-13.5mm, 3.6-11mm
- Water resistance: IP67
- Anti-Cut 3-Axis Bracket
- Size: 220(W) x 80(H) x 80(D)mm
- Weight: 1.4KG



SD PSE Ai

IPC 2MP, 5MP

Carton	46*39*38CM
Quantity	50PCS
Color	White
Voltage	DC12V

- Vandalproof & Weatherproof
- Water Resistance: IP67
- IR LED: 42μ x 2PCS
- IR Range: 20M
- Board Lens 3.6mm
- Size: φ 109 x 93(H) mm
- Weight: 450g



SD PSE

IPC 2MP, 5MP

Carton	55 X42 X42CM
Quantity	12PCS
Color	White
Voltage	DC12V

- Vandalproof & Weatherproof
- IR Dome Camera
- Water Resistance: IP67
- IR LED: 42μ x 2PCS, 20m
- Fixed Lens : 6mm
- Motorized Lens : 2.7-13.5mm
- Size: φ136 x 148(H)mm
- Weight: 1.2Kgs



PSE

IPC 2MP, 5MP

HD 2MP, 5MP Lite, 5MP, 4K lite, 4K

Carton	59*35*49CM
Quantity	16PCS
Color	White
Voltage	DC12V

- IR LED: (42μ) x 4pcs, 40M
- Fixed Lens : 3.6mm
- Motorized Lens : 2.8-12mm, 2.7-13.5mm, 3.6-11mm
- Water resistance: IP67
- Anti-Cut 3-Axis Bracket
- Size: 211(W) x 92(H) x 90(D)mm
- Weight: 1.4KG



PSE

IPC 2MP, 5MP

HD 2MP, 5MP Lite, 5MP, 4K lite, 4K

Carton	59*35*49CM
Quantity	16PCS
Color	White
Voltage	DC12V

- IR LED: (42μ) x 6pcs, 60M
- Fixed Lens : 3.6mm
- Motorized Lens : 2.8-12mm, 2.7-13.5mm, 3.6-11mm
- Water resistance: IP67
- Anti-Cut 3-Axis Bracket
- Size: 211(W) x 92(H) x 90(D)mm
- Weight: 1.4KG



SD PSE

IPC 2MP, 5MP

Carton	46*39*38CM
Quantity	50PCS
Color	White
Voltage	DC12V

- Water resistance: IP67
- IR LED: 42μ x 2PCS, 20m
- Fixed Lens : 6mm
- Motorized Lens : 2.7-13.5mm
- Size: φ128 x 108(H) mm
- Weight: 850g



PSE

IPC 2MP

HD 2MP, 5MP Lite

Carton	54*39*37CM
Quantity	45PCS
Color	White
Voltage	DC12V

- Vandalproof & Weatherproof
- Water Resistance: IP67
- MINI IR Dome Camera
- IR LED: 42μ x 12PCS, 20M
- Fixed Lens : 3.6mm
- Size: φ 110 x 76(H) mm
- Weight: 450



PSE

IPC 2MP, 5MP

HD 2MP, 4MP, 5MP Lite, 5MP, 4K lite, 4K

Carton	59*35*49CM
Quantity	16PCS
Color	White
Voltage	DC12V

- IR LED: 42μ x 4PCS, 40M
- Fixed Lens : 3.6mm
- Motorized Lens : 2.8-12mm, 2.7-13.5mm, 3.6-11mm
- Water resistance: IP67
- Anti-Cut 3-Axis Bracket
- Size: 275(W) x 91(H) x 80(D)mm
- Weight: 1.4KG



PSE

IPC 2MP, 5MP

HD 2MP, 4MP, 5MP Lite, 5MP, 4K lite, 4K

Carton	59*35*49CM
Quantity	16PCS
Color	White
Voltage	DC12V

- IR LED: 42μ x 6PCS, 60M
- Fixed Lens : 3.6mm
- Motorized Lens : 2.8-12mm, 2.7-13.5mm, 3.6-11mm
- Water resistance: IP67
- Anti-Cut 3-Axis Bracket
- Size: 275(W) x 91(H) x 80(D)mm
- Weight: 1.4KG



SD PSE Ai

IPC 2MP

HD 2MP, 4MP, 5MP Lite, 5MP, 4K lite

Carton	52*39*28CM
Quantity	24PCS
Color	White
Voltage	DC12V

- Wide Angle IR Dome
- IR LED: 42μ x 2PCS, 20M
- Fixed Lens : 2.4MM, 2.8mm
- Size: 120(W) x 99(H)
- Weight: 800g



PSE

IPC 2MP

HD 2MP, 5MP Lite

Carton	46*39*38CM
Quantity	50PCS
Color	White
Voltage	DC12V

- Vandalproof & Weatherproof
- Water Resistance: IP67
- MINI IR Dome Camera
- IR LED: 14μ x 12PCS, 20M
- Fixed Lens : 3.6mm
- Size: 94(W) x 94(H) x 72(D)mm
- Weight: 400g



SD **PoE**

IPC	2MP, 5MP, 8MP
HD	2MP, 4MP, 5MP Lite, 5MP, 4K lite, 4K

Carton	46*39*38CM
Quantity	50PCS
Color	White
Voltage	DC12V

- IR LED: 14μ x 18PCS, 20M
- Fixed Lens : 2.8mm, 3.6mm
- Blue, Orange or Black Rubber Ring
- Size: Ø93 x 78 mm
- Weight: 450g

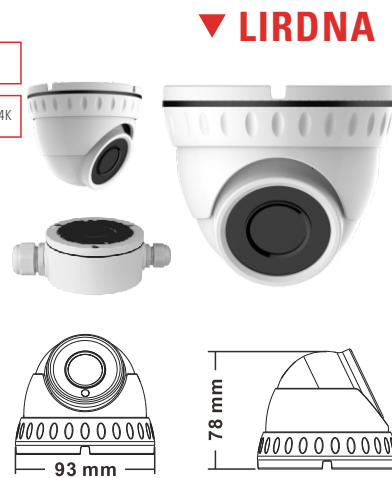

SD **PoE**

IPC	2MP, 5MP
HD	2MP, 4MP, 5MP Lite, 5MP, 4K lite, 4K

Carton	52*39*28CM
Quantity	24PCS
Color	White
Voltage	DC12V

- IR LED: 14μ x 24PCS, 30M
- Fixed Lens : 3.6mm
- Motorized Lens : 2.8-12mm, 2.7-13.5mm, 3.6-11mm
- Blue, Orange or Black Rubber Ring
- Size: Ø120 x 98(H) mm
- Weight: 800g



LCDNK20

HD	2MP, 5MP Lite, 5MP, 4K lite
-----------	-----------------------------

Carton	52*39*28CM
Quantity	24PCS
Color	White
Voltage	DC12V

- Plastic IR Dome Camera
- IR LED: 16μ x 8PCS, 20M
- Motorized Lens : 2.8-12mm
- Size: Ø 112 x 87(H) mm
- Weight: 600g



WiFi **SD** **PoE**

IPC	2MP, 5MP, 8MP, 12MP
HD	2MP, 5MP, 4K lite, 4K

Carton	55 X42 X42CM
Quantity	12PCS
Color	White
Voltage	DC12V

- Vandalproof & Weatherproof
- IR Dome Camera
- Water Resistance: IP67
- IR LED: 42μ x 4PCS, 40m
- Fixed Lens : 3.6mm
- Motorized Lens : 2.8-12mm, 2.7-13.5mm, 3.6-11mm
- Size: Ø136 x 148(H)mm
- Weight: 1.7Kgs



SD **PoE**

IPC	2MP, 5MP, 8MP
HD	2MP, 4MP, 5MP Lite, 5MP, 4K lite, 4K

Carton	46*39*38CM
Quantity	50PCS
Color	White
Voltage	DC12V

- Water resistance: IP67
- IR LED: 14μ x 18PCS, 20m
- Fixed Lens : 2.8mm, 3.6mm
- Size: Ø93 x 74(H) mm
- Weight: 400g



PoE

IPC	2MP, 5MP
HD	2MP, 4MP, 5MP Lite, 5MP, 4K lite, 4K

Carton	46*39*38CM
Quantity	50PCS
Color	White
Voltage	DC12V

- IR Dome Camera
- Water resistance: IP67
- NEW IR LED: 14μ x 24PCS, 30m
- Fixed Lens : 3.6mm
- Motorized Lens : 2.8-12mm, 2.7-13.5mm, 3.6-11mm
- Size: Ø119 x 98(H) mm
- Weight: 800g



LIRDLA

IPC	2MP
HD	2MP, 5MP Lite, 5MP

Carton	46*39*38CM
Quantity	50PCS
Color	White
Voltage	DC12V

- Plastic IR Dome Camera
- IR LED: 14μ x 18PCS, 20M
- Fixed Lens : 2.8mm, 3.6mm
- Size: 90.5 x 80 x 80mm
- Weight: 300g



WiFi **SD** **PoE**

IPC	5MP
HD	2MP, 5MP Lite

Carton	52*39*28CM
Quantity	30PCS
Color	White
Voltage	DC12V

- Standard Box Camera
- Iris control: DC
- DC Iris Lens, F1.4 CS
- 2.8-12mm Manual Zoom Lens
- 300W HD Lens
- Size: 148(W)x79(H)x57(D)mm
- Weight: 585g

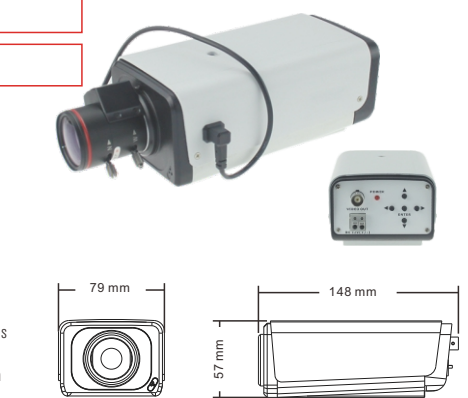

WiFi **PoE** **Ai**

IPC	2MP, 5MP, 8MP, 12MP
HD	2MP, 4MP, 5MP Lite, 5MP, 4K lite, 4K

Carton	55*42*42CM
Quantity	12PCS
Color	White
Voltage	DC12V

- IR Dome Camera
- Water resistance: IP67
- IR LED: 42μ x 4PCS, 30M
- Fixed Lens : 3.6mm
- Motorized Lens : 2.8-12mm, 2.7-13.5mm, 3.6-11mm
- Size: Ø139 x 122(H) mm
- Weight: 800g



PoE

IPC	2MP
HD	2MP, 5MP Lite

Carton	46*39*38CM
Quantity	50PCS
Color	White
Voltage	DC12V

- Vandalproof & Weatherproof
- Water Resistance: IP67
- MINI IR Dome Camera
- IR LED: 14μ x 12PCS, 20M
- Fixed Lens : 3.6mm
- Size: 94(W) x 94(H) x 72(D)mm
- Weight: 400g



LIRDM

HD	2MP, 5MP Lite
-----------	---------------

Carton	54*39*37CM
Quantity	100PCS
Color	White
Voltage	DC12V

- IR LED: Ø 5 (12μ) x 12PCS, 10M
- Fixed Lens : 3.6mm
- Size: Ø 59x 55(H) mm
- Weight: 300g



LSDC

HD	2MP, 5MP Lite, 5MP
-----------	--------------------

Carton	54*39*37 CM
Quantity	48PCS
Color	White
Voltage	DC12V

- Fixed Lens : 3.6mm
- Size: Ø 119 x 56(H) mm
- Weight: 350g

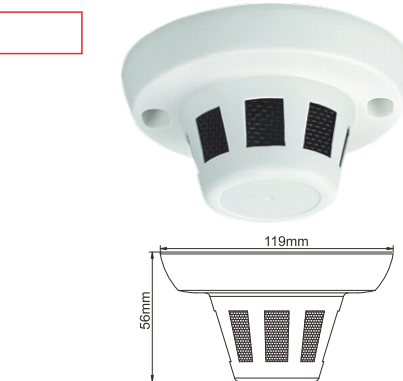

IPC 2MP

LMEMPSSL2002 LMEMPSSL2008

Carton	54*39*37CM
Quantity	100PCS
Color	Black
Voltage	DC12V

- Miniature Camera
- 3.7mm Pinhole Lens/82° (F2.8)
- Lens with 2M/8M Cable
- Brackets Included
- Size: 104(L) x 78(W) x 25.8(H)mm
- Weight: 770g

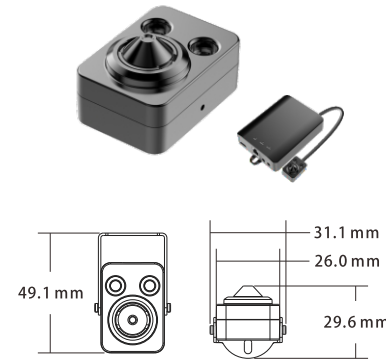

IPC 5MP

LMEMPCSL2002 LMEMPCSL2008

Carton	54*39*37CM
Quantity	100PCS
Color	Black
Voltage	DC12V

- Miniature Camera
- 3.7mm Pinhole Lens/82° (F2.8)
- Lens with 2M/8M Cable
- Two Brackets Included
- Size: 104(L) x 78(W) x 25.8(H)mm
- Weight: 790g

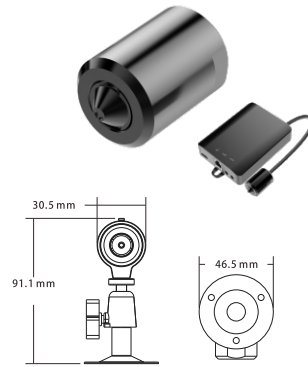

HD 1.3MP

LBPA

Carton	54*39*37CM
Quantity	100PCS
Color	Black
Voltage	DC12V

- Fixed Lens : 3.6mm
- Size: Ø20 x 46 mm
- Weight: 200g



HD 1.3MP

LBBA

Carton	54*39*37CM
Quantity	100PCS
Color	Black
Voltage	DC12V

- Fixed Lens : 3.7mm
- Size: Ø19 x 46(H) mm
- Weight: 200g

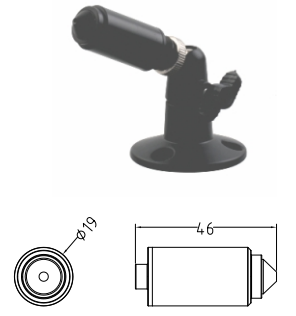

IPC 2MP

LMEMTCSL2002 LMEMTCSL2008

Carton	54*39*37CM
Quantity	100PCS
Color	Black
Voltage	DC12V

- Miniature Camera
- 2.8mm /106° (F1.6)
- Lens with 2M/8M Cable
- Two Brackets Included
- Size: 104(L) x 78(W) x 25.8(H)mm
- Weight: 810g



HD 2MP

LMEMPCHTC200ESL

Carton	54*39*37CM
Quantity	100PCS
Color	Black
Voltage	DC12V

- Miniature Camera
- 3.7mm Taper Pinhole Lens
- Size: Φ 30.5x 91(H) mm
- Weight: 300g
- Include two brackets



HD 1.3MP, 2MP

LMCM25

Carton	52*39*28CM
Quantity	150PCS
Color	Black
Voltage	DC12V

- Fixed Lens : 3.7mm
- Size: 25(W) x 10(H) x 25(D)mm
- Weight: 150g

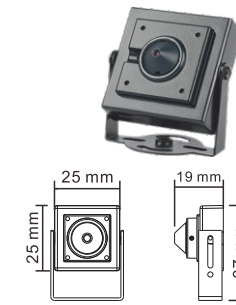

HD 1.3MP, 2MP

LMCM30

Carton	52*39*28CM
Quantity	150PCS
Color	Black
Voltage	DC12V

- Fixed Lens : 3.7mm
- Size: 30(W) x 33(H) x 30(D)mm
- Weight: 150g

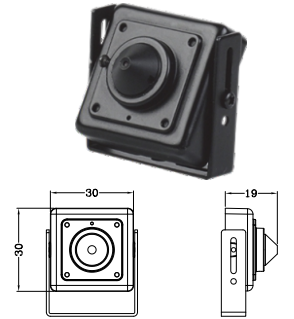

WiFi **SD** **POE**

IPC 2MP

LMCM36

Carton	52*39*28CM
Quantity	100PCS
Color	Black
Voltage	DC12V

- Size: 25(L) x 36*36*27mm
- Fixed Lens : 2.8mm, 3.7mm
- Weight: 300g



HD 1.3MP, 2MP

LMBM25

Carton	52*39*28CM
Quantity	150PCS
Color	Black
Voltage	DC12V

- Size: 25(L) x 25(W) x 28(H)mm
- Fixed Lens : 2.8mm, 3.6mm
- Weight: 150g



LMEMPCHTC200ESL

HD 2MP

Carton	54*39*37CM
Quantity	100PCS
Color	Black
Voltage	DC12V

- Miniature Camera
- 2.8mm Board Lens
- Size: Φ 30.5x 91(H) mm
- Weight: 300g
- Include two brackets



HD 2MP, 5MP Lite

LPRC

Carton	51*39*35CM
Quantity	40PCS
Color	White
Voltage	DC12V

- Fixed Lens : 3.7mm Taper Pinhole Lens
- Size: 70(W) x 40(H) x 119(D)mm
- Weight: 350g



HD 1.3MP, 2MP

LMBM30

Carton	52*39*28CM
Quantity	150PCS
Color	Black
Voltage	DC12V

- Fixed Lens : 2.8mm, 3.6mm
- Size: 30(W) x 33(H) x 30(D)mm
- Weight: 150g



WiFi **SD** **POE**

IPC 2MP

LMBM36

Carton	54*39*37CM
Quantity	100PCS
Color	Black
Voltage	DC12V

- Fixed Lens : 2.8mm, 3.7mm
- Size: 36*36*33mm
- Weight: 300g

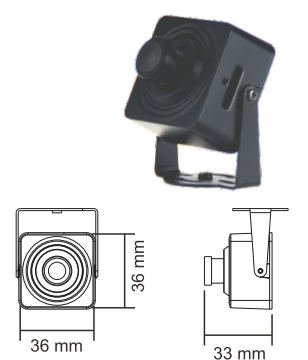



PTZ SPEED DOME

IP AHD TVI

- P2P
- Lightning Protection
- DDNS
- HD 5MP
- H.265
- IP66
- ONVIF 2.0
- Vandalproof
- MOTION DETECTION
- IR-CUT



PTZ SPEED DOME

4X / 5X / 10X / 18X / 20X / 22X / 33X / 36X optical zoom



Night Vision:

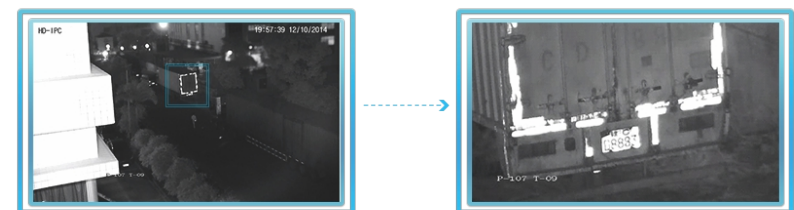



360° Rotation, No Surveillance Blind Spots

Horizontal direction of rotation 360 degree continuous rotation, vertical 93 degrees, auto flip, no surveillance blind spots



Lightning Protection
Transient Voltage 6000V

33X Optical Zoom

IR LEDS

Built-in Cable:
RS485 wire to control PTZ

Metal Case, Weatherproof IP66

Auto Temperature Control
-40°C ~ +60°C

The details of PTZ

Supported Browsers

IE8-11, Firefox, Google Chrome



Support Multi Platforms In Real Time Viewing

Support Windows, iPhone, Android platform smartphone. Secure you anytime anywhere!



- ✓ | iPhone
- ✓ | Android
- ✓ | Computer
- ✓ | Pad

5MP High Definition Image

1/2.5" Aptina 5.1MP High Performance CMOS Sensor, 33X optical zoom.



Advanced Motion Detection Recording

The motion detection options allow you to record only when motion is detected to save hard drive space without missing important events. You can even ensure that false alarms are avoided by setting the motion detection "mask" to block areas with constant movement.

Motion Detection

Automatic Video / Save Worry



PTZ Camera

PTZ Camera

IP

2MP 4X

Starlight









Ai

Key Features

- 2.5" Mini AI Tracking IP PTZ
- Weatherproof Outdoor Ip66
- 30µx 4PCS IR LEDs, IR Range: 45M
- Tracking effective range: 3-15M
- Pan Range: 0° ~ 350°, Pan Speed: 30°/sec
- Tilt Range: 0° ~ 93°, Tilt Speed: 25°/sec
- Preset Points: 220
- Guard Tours: 3 Groups
- Guard Points: Max. 16 points
- TCP/IP, HTTP, NTP, IGMP, DHCP, UDP, SMTP, RTP, RTSP, ARP, DDNS, DNS, PPPoE, Support
- P2P Support
- Lightning Protection: Transient Voltage 6000V
- Support Two-Way Audio
- Size of Package (LxWxH): 20.7x21.7 x 14.2 (cm)
- Weight: 0.8 Kgs



PT2A

IP

2MP 18X

Starlight

Ai

Key Features

- 4.5" 18X AI Tracking IP PTZ
- Weatherproof Outdoor Ip66
- 30µx 6PCS IR LEDs, IR Range: 60M
- Tracking effective range: 5-45M Speed: 3-12KM/h
- Pan Range: 0° ~ 360°, Pan Speed: 120°/sec
- Tilt Range: 0° ~ 93°, Tilt Speed: 30°/sec
- Preset Points: 220
- Guard Tours: 3 Groups
- Guard Points: Max. 16 points
- TCP/IP, HTTP, NTP, IGMP, DHCP, UDP, SMTP, RTP, RTSP, ARP, DDNS, DNS, PPPoE, Support
- P2P Support
- Lightning Protection: Transient Voltage 8000V
- Support Two-Way Audio
- Size of Package (LxWxH): 18.5x 18.5 x 28.8 (cm)
- Weight: 2.2 Kgs



PT4A









IP

2MP 18X

Starlight

Ai

Key Features

- 4.5" 18X AI Tracking IP PTZ
- Weatherproof Outdoor Ip66
- 8 PCS matrix high power warm light
- Tracking effective range: 5-45M Speed: 3-12KM/h
- Pan Range: 0° ~ 350°, Pan Speed: 80°/sec
- Tilt Range: -45° ~ 40°, Tilt Speed: 45°/sec
- Preset Points: 220
- Guard Tours: 3 Groups
- Guard Points: Max. 16 points
- TCP/IP, HTTP, NTP, IGMP, DHCP, UDP, SMTP, RTP, RTSP, ARP, DDNS, DNS, PPPoE, Support
- P2P Support
- Lightning Protection: Transient Voltage 6000V
- Support Two-Way Audio
- Size of Package (LxWxH): 18.5x 18.5 x 28.8 (cm)
- Weight: 2.2 Kgs



PT4B









IP

2MP 18X

Starlight

Ai

Key Features

- 6" 18X AI Tracking IP PTZ
- Weatherproof Outdoor Ip66
- 7PCS IR LEDs, 2 laser lights, IR Range 120M
- Tracking effective range: 5-80M Speed: 3-12KM/h
- Pan Range: 0° ~ 360°, Pan Speed: 80°/sec
- Tilt Range: 0° ~ 93°, Tilt Speed: 60°/sec
- Preset Points: 220
- Guard Tours: 3 Groups
- Guard Points: Max. 16 points
- TCP/IP, HTTP, NTP, IGMP, DHCP, UDP, SMTP, RTP, RTSP, ARP, DDNS, DNS, PPPoE, Support
- P2P Support
- Lightning Protection: Transient Voltage 8000V
- Support Two-Way Audio
- Size of Package (LxWxH): 25.5 x 21.5 x 41.0 (cm)
- Weight: 3.1 Kgs



PT6A









PTZ Camera

PTZ Camera

IP

2MP 4X 10X

5MP 4X 10X

Starlight

Ai



PTDK









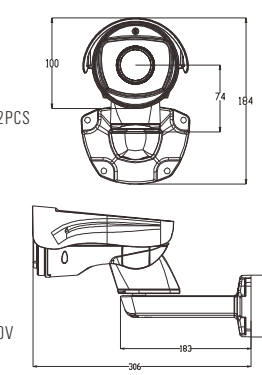

Key Features

- 4X AI Tracking IP PTZ
- Weatherproof Outdoor Ip66
- 35µx 6PCS IR LEDs/ 4PCS Array IR LEDs + 2PCS Laser Lamp
- Tracking effective range: 3-15M
- IR Range: 80m/ 100m
- Pan Range: 0° ~ 180°, Pan Speed: 30°/sec
- Tilt Range: -45° ~ 40°, Tilt Speed: 25°/sec
- Guard Tours: 3 Groups
- Guard Points: Max. 16 points
- RS485, Pelco D/P Support
- OSD Menu Available
- Lightning Protection: Transient Voltage 6000V
- Size of Package (LxWxH): 39.6x19.6x16(cm)
- Weight: 3Kgs



IP

2MP 4X

5MP 4X

Starlight



PTDA









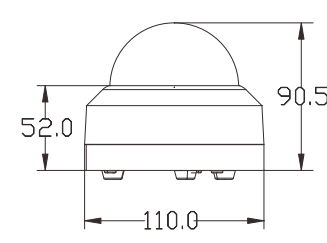

Key Features

- 2.5" HD-IP Mini Dome Camera
- Weatherproof Outdoor Ip66
- 35µx 4PCS IR LEDs, IR Range: 35m
- Pan Range: 0° ~ 355° Continue; Tilt Range: 0° ~ 70° Flip
- Pan Speed: 25°/sec; Tilt Speed: 20°/sec
- Preset Points: 220
- TCP/IP, HTTP, FTP, RTSP Support
- P2P Support
- TVS6000V Lighting Protection, Surge Protection and Voltage
- Transient Protection
- Size of Package (LxWxH): 14x14x13(cm)
- Weight: 1.1Kgs



IP

2MP 4X

5MP 5X



PTDC









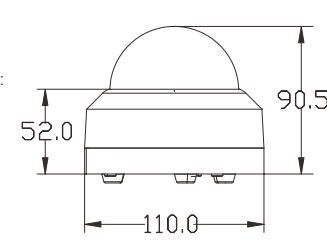

Key Features

- 2.5" HD-IP Mini Dome Camera
- Weatherproof Outdoor Ip66
- 42x2PCS IR LEDs, IR Range: 25m
- Pan Range: 0° ~ 355° Continue; Tilt Range: 0° ~ 90° Flip
- Pan Speed: 25°/sec; Tilt Speed: 20°/sec
- Preset Points: 16
- RS485, Pelco D/P Support
- OSD Menu Available
- Power Adaptor: DC12V/1A
- TVS3000V Lighting Protection, Surge Protection and Voltage
- Transient Protection
- Size of Package (LxWxH): 14x14x12.6(cm)
- Weight: 1.1Kgs



PTZ Camera

PTZ Camera

IP Starlight

2MP **22X**
5MP **22X**

HD
AHD TVI CVBS

2MP **18X**



PT5A

Key Features

- 5" HD-IP Medium Speed Dome Camera
- Weatherproof Outdoor IP66
- 42x8PCS IR LEDs, IR Range: 60m
- Pan Range: 0° ~ 360° Continue; Tilt Range: 0° ~ 93° Flip
- Pan Speed: 45°/sec; Tilt Speed: 30°/sec
- Preset Points: 220
- Guard Tours: 3 Groups
- Guard Points: Max.16 points
- TCP/IP, HTTP, FTP, RTSP Support
- P2P Support
- Power Adaptor: DC12V/3A
- Lightning Protection: Transient Voltage 6000V
- Size of Package (LxWxH): 29.5x28x17(cm)
- Weight: 2.5Kgs

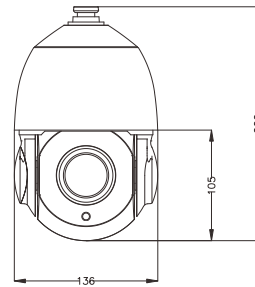

PTZ Camera

PTZ Camera

IP Starlight

2MP **22X > 36X**
5MP **20X > 36X**

HD
AHD TVI CVBS

2MP **18X > 33X**



PT7E

Key Features

- 7" High Speed Dome Camera
- 3IN1: AHD/HD-TVI/CVBS
- Weatherproof Outdoor IP66
- 42x8PCS IR LEDs, IR Range: 120m
- Pan Range: 0° ~ 360° Continue; Tilt Range: 0° ~ 93° Flip
- Pan Speed: 120°/sec; Tilt Speed: 60°/sec
- Preset Points: 220
- Guard Tours: 3 Groups
- Guard Points: Max.16 points
- RS485, Pelco D/P Support
- OSD Menu Available
- Power Adaptor: DC12V/3A
- Lightning Protection: Transient Voltage 6000V
- Size of Package (LxWxH): 31x31x44(cm)
- Weight: 10.2Kgs

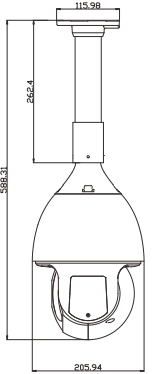

IP Starlight

2MP **22X**
5MP **22X**

HD
AHD TVI CVBS

2MP **18X**



PT5E

Key Features

- 5.5" HD-IP High Speed Dome Camera
- Weatherproof Outdoor IP66
- 7PCS Array IR LEDs + 2PCS Laser Lamp, IR Range: 180m
- Pan Range: 0° ~ 360° Continue; Tilt Range: 0° ~ 93° Flip
- Pan Speed: 120°/sec; Tilt Speed: 60°/sec
- Preset Points: 220
- Guard Tours: 3 Groups
- Guard Points: Max.16 points
- TCP/IP, HTTP, FTP, RTSP Support
- P2P Support
- Power Adaptor: DC12V 2A/3A
- Lightning Protection: Transient Voltage 6000V
- Size of Package (LxWxH): 25x21.5x41(cm)
- Weight: 4.9Kgs

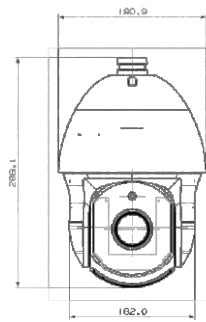

IP Starlight

2MP **22X > 36X**
5MP **20X > 36X**

HD
AHD TVI CVBS

2MP **18X > 33X**



PT7K

Key Features

- 7" HD-IP High Speed Dome Camera
- Weatherproof Outdoor IP66
- 42x8PCS IR LEDs + 2PCS LED Laser, IR Range: 150m
- Pan Range: 0° ~ 360° Continue; Tilt Range: 0° ~ 93° Flip
- Pan Speed: 120°/sec; Tilt Speed: 30°/sec
- Preset Points: 220
- Guard Tours: 3 Groups
- Guard Points: Max.16 points
- TCP/IP, HTTP, FTP, RTSP Support
- P2P Support
- Power Adaptor: DC12V/4A
- Lightning Protection: Transient Voltage 6000V
- Size of Package (LxWxH): 31x31x44(cm)
- Weight: 10.7Kgs

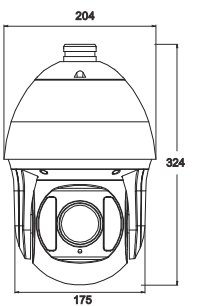

IP Starlight

2MP **22X**
5MP **22X**

HD
AHD TVI CVBS

2MP **18X**
5MP **18X**



PT5D

Key Features

- 5.5" HD-IP High Speed Dome Camera
- Weatherproof Outdoor IP66
- 42x8PCS IR LEDs, IR Range: 120m
- Pan Range: 0° ~ 360° Continue; Tilt Range: 0° ~ 90° Flip
- Pan Speed: 220°/sec; Tilt Speed: 30°/sec
- Preset Points: 220
- Guard Tours: 8 Groups
- Guard Points: Max.32 points
- TCP/IP, HTTP, FTP, RTSP Support
- P2P Support
- Power Adaptor: DC12V 4A
- TVS3000V Lightning Protection, Surge Protection and Voltage
- Transient Protection
- Size of Package (LxWxH): 26.5x26.5x42(cm)
- Weight: 9.7Kgs

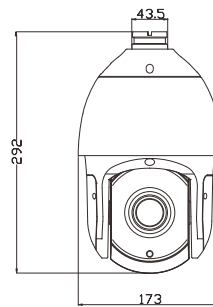

IP Starlight

2MP **36X**
5MP **20X > 36X**

HD
AHD TVI CVBS

2MP **18X**
5MP **18X**



PT10G

Key Features

- 10" HD-IP High Speed Dome Camera
- Weatherproof Outdoor IP66
- 42 x 8PCS IR LEDs + 4PCS LED Laser, IR Range: 200m
- Pan Range: 0° ~ 360° Continue; Tilt Range: 0° ~ 90° Flip
- Pan Speed: 200°/sec; Tilt Speed: 100°/sec
- Preset Points: 220
- Guard Tours: 3 Groups
- Guard Points: Max.16 points
- TCP/IP, HTTP, FTP, RTSP Support
- P2P Support
- Power Adaptor: DC12V/4A
- Lightning Protection: Transient Voltage 6000V
- Size of Package (LxWxH): 33x33x52(cm)
- Weight: 13.7Kgs

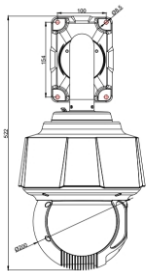

Longse

NVR/XVR/DVR



- NVR
- POE (NVR)
- WIFI (NVR)
- 5IN1 (XVR)
- SDI (DVR)

1 P2P Connection

You may register a new account in our server, it's free for life. Or a simplest solution to connect your video recorder, just scan the QR Code on video recorder's screen, you can directly connect to it. Thanks to P2P advance feature that built in the recorder.

- Free for lifetime.
- Easy access.
- Centralized video recorder management.
- Plug and view from everywhere.
- Support 5G.



2 Powerful Mobile Surveillance

By searching "bitvision" in App store or in Play Store, you may download the software for your mobile phone easily.

Supported Mobile OS:-
Please scan the QR code for download Maxsecure App software

Its support :

- Liveview
- Mobile Record and Snapshot
- PTZ Camera Control

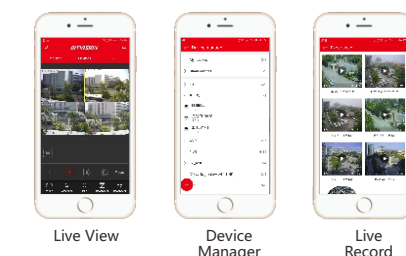

3 Email Notifications

When an event happens and is detected, Instant event will send to your iPhone, iPad and Android mobile devices, keeps an eye on your properties and never gets asleep.



4 Client Webserver Software

With Longse Client Software, user only key in user name and password to manage their video recorders. Longse Client Software supports up to 64 Channel camera liveview per screen with unlimited XVR device support. You can easily view via the recorder in each location at the same time in a single screen. You also have the full gain control like playback, PTZ Camera control, etc on the recorder. It supports all kinds of recorders.



5 Full 1080P Record Resolution

Enjoy HD 1080P video records with smooth playback at up to 30 frames per second, express the objects in the most vivid detail.



6 New Designed UI Interface

New simple and easy Linux Base interface design.

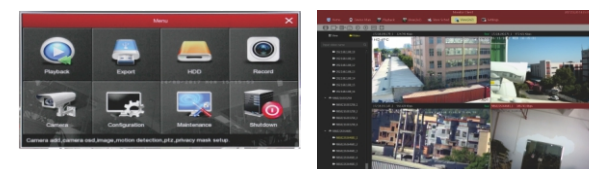

7 Multiple Video Output

Support HD, VGA, BNC
3840 X 2160
2560 X 1440
1920 X 1080
1280 X 1024
1280 X 720
1024 X 768



XVR/NVR/SDI DVR Features

P2P remote control

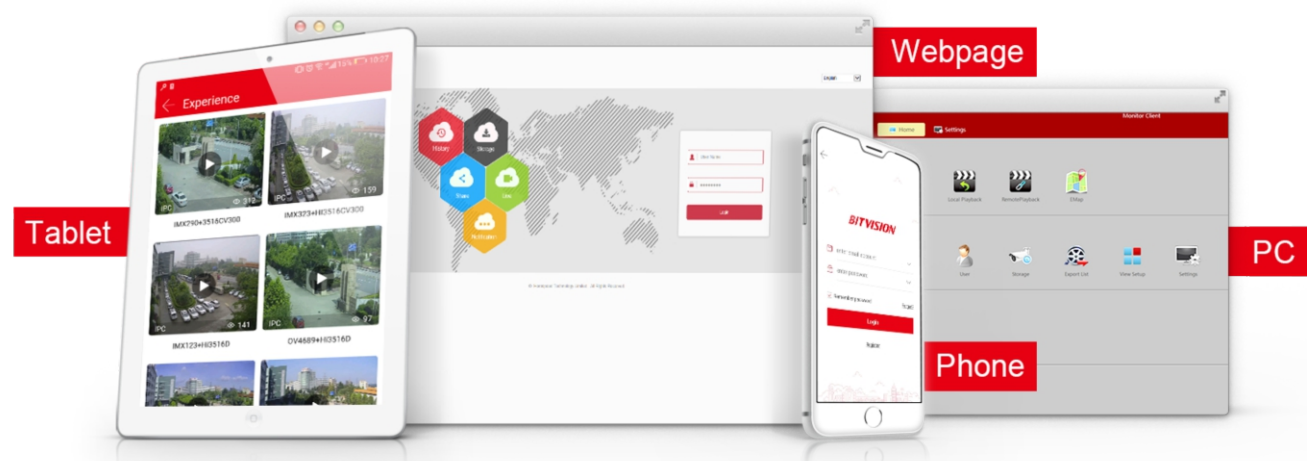

Remote View by Smart Phone

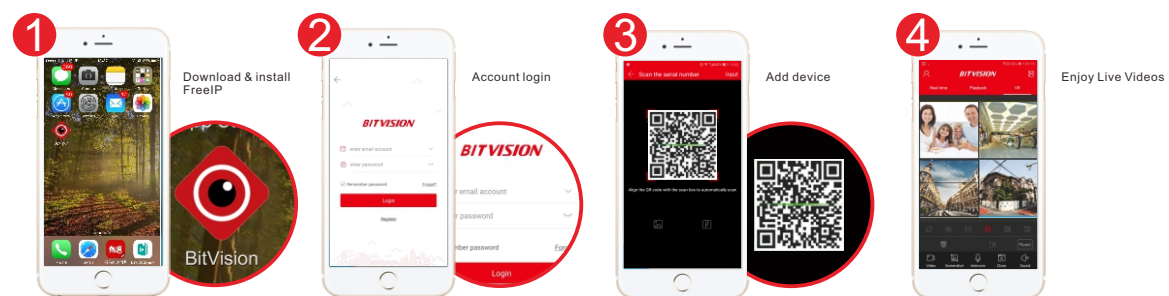

Remote View by IE

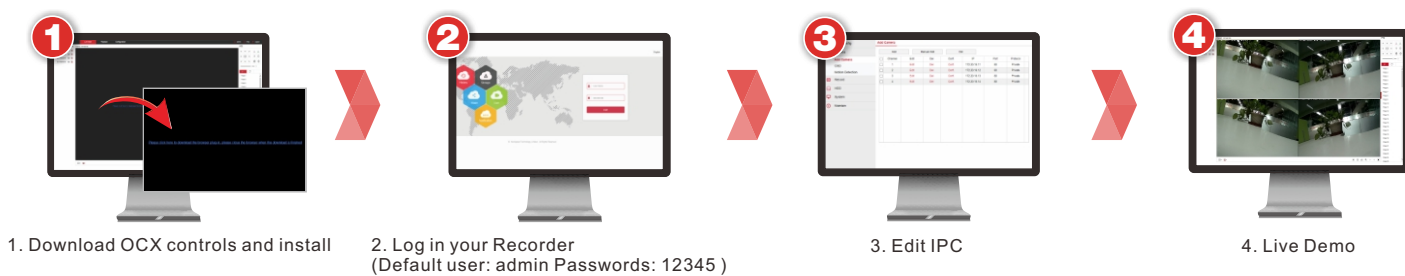

Remote View by VMSLite



XVR/NVR Monitoring

	Live View	Play back	Set-up	Multi-Stream
Local	✓	✓	✓	✓
IE Browser	✓	✓	✓	✓
VMS VMS	✓	✓	✓	✓
SmartPhone	✓	✓	✓	✓

Suggested HDD for Recorder



(The recording time is only for reference, should according to the actual situation)

Channel HDD	Record Resolution	Rate		4CH		8CH		16CH	
		H.264	H.265	H.264	H.265	H.264	H.265	H.264	H.265
1TB	4K	8192 Kbps	4096 Kbps	3.0 Days	5.9 Days	1.5 Days	3.0 Days	0.7 Days	1.5 Days
	4MP	6020 Kbps	3010 Kbps	4.0 Days	8.1 Days	2.0 Days	4.0 Days	1.0 Days	2.0 Days
	1080P	4096 Kbps	2048 Kbps	5.9 Days	11.9 Days	3.0 Days	5.9 Days	1.5 Days	3.0 Days
	720P	2048 Kbps	1024 Kbps	11.9 Days	/	5.9 Days	/	3.0 Days	/
2TB	4K	8192 Kbps	4096 Kbps	5.9 Days	11.9 Days	3.0 Days	5.9 Days	1.5 Days	3.0 Days
	4MP	6020 Kbps	3010 Kbps	8.1 Days	16.1 Days	4.0 Days	8.1 Days	2.0 Days	4.0 Days
	1080P	4096 Kbps	2048 Kbps	11.9 Days	23.7 Days	5.9 Days	11.9 Days	3.0 Days	5.9 Days
	720P	2048 Kbps	1024 Kbps	23.7 Days	/	11.9 Days	/	5.9 Days	/
3TB	4K	8192 Kbps	4096 Kbps	8.9 Days	17.8 Days	4.4 Days	8.9 Days	2.2 Days	4.4 Days
	4MP	6020 Kbps	3010 Kbps	12.1 Days	24.2 Days	6.0 Days	12.1 Days	3.0 Days	6.0 Days
	1080P	4096 Kbps	2048 Kbps	17.8 Days	35.6 Days	8.9 Days	17.8 Days	4.4 Days	8.9 Days
	720P	2048 Kbps	1024 Kbps	35.6 Days	/	17.8 Days	/	8.9 Days	/
4TB	4K	8192 Kbps	4096 Kbps	11.9 Days	23.7 Days	5.9 Days	11.9 Days	3.0 Days	5.9 Days
	4MP	6020 Kbps	3010 Kbps	16.1 Days	32.3 Days	8.1 Days	16.1 Days	4.0 Days	8.1 Days
	1080P	4096 Kbps	2048 Kbps	23.7 Days	47.4 Days	11.9 Days	23.7 Days	5.9 Days	11.9 Days
	720P	2048 Kbps	1024 Kbps	47.4 Days	/	23.7 Days	/	11.9 Days	/
6TB	4K	8192 Kbps	4096 Kbps	17.8 Days	35.6 Days	8.9 Days	17.8 Days	4.4 Days	8.9 Days
	4MP	6020 Kbps	3010 Kbps	24.2 Days	48.4 Days	12.1 Days	24.2 Days	6.0 Days	12.1 Days
	1080P	4096 Kbps	2048 Kbps	35.6 Days	71.1 Days	17.8 Days	35.6 Days	8.9 Days	17.8 Days
	720P	2048 Kbps	1024 Kbps	71.1 Days	/	35.6 Days	/	17.8 Days	/

4K/5MP H.265+ POE NVR



- Model:**
NVR3604PGP
- Key Features:**
- IP Camera Input: 9CH (5M/4M/3M/2M/1M, etc)
 - POE: 4 x Independent 100Mbps PoE Network Interfaces (Total Power Output \geq 50W)
 - Compression Method: H.265/H.265+, H.264/H.264+
 - Recording Resolution: 5M/4M/3M/1080P/960P/720P, etc (All Real Time)
 - HD Output/VGA Output: 1920 x 1080/1280 x 1024/1280 x 720
 - Audio Input/Output: 1CH RCA Input/1CH RCA Output
 - Interface: 5xRJ-45 10/100Mbps Self-adaptive Ethernet Interfaces, 2xUSB2.0
 - Storage: 1xSATA (MAX 8TB HDD)
 - Power Input: DC52V/1250mA
 - Dimension(W x D x H): 220*219*50(mm)



- Model:**
NVR3604DP
- Key Features:**
- IP Camera Input: 9CH (5M/4M/3M/2M/1M, etc)
 - POE: 4 x Independent 100Mbps PoE Network Interfaces (Total Power Output \geq 50W)
 - Compression Method: H.265/H.265+, H.264/H.264+
 - Recording Resolution: 5M/4M/3M/1080P/960P/720P, etc (All Real Time)
 - HD Output/VGA Output: 1920 x 1080/1280 x 1024/1280 x 720
 - Audio Input/Output: 1CH RCA Input/1CH RCA Output
 - Interface: 5xRJ-45 10/100Mbps Self-adaptive Ethernet Interfaces, 2xUSB2.0
 - Storage: 1xSATA (MAX 8TB HDD)
 - Power Input: DC52V/1250mA
 - Dimension(W x D x H): 260*215*43(mm)

4K H.265+ POE NVR



- Model:**
NVR3616HP
- Key Features:**
- IP Camera Input: 25CH (8M/6MP/5MP/4MP/3MP/2MP/1MP, etc)
 - POE: 16 x Independent 100Mbps PoE Network Interfaces (Total Power Output \geq 200W)
 - Compression Method: H.265/H.265+, H.264/H.264+
 - Recording Resolution: 8M/5M/4M/3M/1080P/960P/720p, etc (All Real Time)
 - HD Output/VGA Output: 8M (3840 x 2160)/ 1920 x 1080/1280 x 1024/1280 x 720
 - Audio: 1CH RCA Input/1CH RCA Output
 - Alarm: 16CH Input/4CH Output
 - Interface: 16xRJ-45 10/100Mbps + 1xRJ-45 10/100/1000Mbps Self-adaptive Ethernet Interfaces, 1xRS485, 2xUSB2.0
 - Storage: 4xSATA (MAX 32TB HDD)
 - Power Input: AC 100V-240V
 - Dimension(W x D x H): 439*367*69(mm)



- Model:**
NVR3604CDP
- Key Features:**
- IP Camera Input: 16CH (5M/4M/3M/2M/1M, etc)
 - POE: 4 x Independent 100Mbps PoE Network Interfaces (Total Power Output 50W)
 - Compression Method: H.265/H.265+, H.264/H.264+
 - Recording Resolution: 4K/5M/4M/3M/1080P/960P/720p, etc (All Real Time)
 - HD Output/VGA Output: 4K (3840 x 2160)/ 1920 x 1080/1280 x 1024/1280 x 720
 - Audio 1CH In/1CH Out, Alarm 4CH In/1CH Out
 - Interface: 4xRJ-45 10/100Mbps Self-adaptive Ethernet Interfaces, 2xUSB2.0
 - Support network cable extended mode Max. 250M
 - Storage: 1xSATA (MAX 6TB HDD)
 - Power Input: DC52V/1250mA
 - Dimension(W x D x H):260*215*43(mm)



- Model:**
NVR3608DP
- Key Features:**
- IP Camera Input: 9CH (5M/4M/3M/2M/1M, etc)
 - POE: 8 x Independent 100Mbps PoE Network Interfaces (Total Power Output \geq 100W)
 - Compression Method: H.265/H.265+, H.264/H.264+
 - Recording Resolution: 5M/4M/3M/1080P/960P/720P, etc (All Real Time)
 - HD Output/VGA Output: 1920 x 1080/1280 x 1024/1280 x 720
 - Audio Output: 1CH 3.5mm Headphone Socket
 - Interface: 9xRJ-45 10/100Mbps Self-adaptive Ethernet Interfaces, 2xUSB2.0
 - Storage: 1xSATA (MAX 8TB HDD)
 - Power Input: DC52V/1250mA
 - Dimension(W x D x H):260*215*43(mm)



- Model:**
NVR3616KP
- Key Features:**
- IP Camera Input: 25CH (8M/6MP/5MP/4MP/3MP/2MP/1MP, etc)
 - POE: 16 x Independent 100Mbps PoE Network Interfaces (Total Power Output \geq 200W)
 - Compression Method: H.265/H.265+, H.264/H.264+
 - Recording Resolution: 8M/5M/4M/3M/1080P/960P/720p, etc (All Real Time)
 - HD Output/VGA Output: 8M (3840 x 2160)/ 1920 x 1080/1280 x 1024/1280 x 720
 - Audio Input/Output: 1CH RCA Input/1CH RCA Output
 - Interface: 16xRJ-45 10/100Mbps + 1xRJ-45 10/100/1000Mbps Self-adaptive Ethernet Interfaces, 2xUSB2.0
 - Storage: 4xSATA (MAX 32TB HDD)
 - Power Input: AC 100V-240V
 - Dimension(W x D x H): 440*356*72(mm)



- Model:**
NVR3608CDP
- Key Features:**
- IP Camera Input: 16CH (8M/6MP/5MP/4MP/3MP/2MP/1MP, etc)
 - POE: 8 x Independent 100Mbps PoE Network Interfaces (Total Power Output 100W)
 - Compression Method: H.265/H.265+, H.264/H.264+
 - Recording Resolution: 4K/5M/4M/3M/1080P/960P/720p, etc (All Real Time)
 - HD Output/VGA Output: 4K (3840 x 2160)/ 1920 x 1080/1280 x 1024/1280 x 720
 - Audio 1CH In/1CH Out, Alarm 4CH In/1CH Out
 - Interface: 8xRJ-45 10/100Mbps + 1xRJ-45 10/100/1000Mbps Self-adaptive Ethernet Interfaces, 2xUSB2.0
 - Support network cable extended mode Max. 250M
 - Storage: 1xSATA (MAX 6TB HDD)
 - Power Input: DC52V/2500mA
 - Dimension(W x D x H):260*215*43(mm)



- Model:**
NVR3616CDBP
- Key Features:**
- IP Camera Input: 25CH (8M/6MP/5MP/4MP/3MP/2MP/1MP, etc)
 - POE: 16 x Independent 100Mbps PoE Network Interfaces (Total Power Output 200W)
 - Compression Method: H.265/H.265+, H.264/H.264+
 - Recording Resolution: 8M/5M/4M/3M/1080P/960P/720p, etc (All Real Time)
 - HD Output/VGA Output: 8M (3840 x 2160)/ 1920 x 1080/1280 x 1024/1280 x 720
 - Audio 1CH In/1CH Out
 - Interface: 16xRJ-45 10/100Mbps + 1xRJ-45 10/100/1000Mbps Self-adaptive Ethernet Interfaces, 1xRS485, 2xUSB2.0
 - Support network cable extended mode Max. 250M
 - Storage: 1xSATA (MAX 6TB HDD)
 - Power Input: AC 100V-240V
 - Dimensions (L x W x H): 310*295*46(mm)

5MP H.265+ NVR



- Model:**
NVR3609D
- Key Features:**
- IP Camera Input: 9CH (5M, 3M, 2M, 1.3M, 1M, etc)
 - Compression Method: H.265/H.265+, H.264/H.264+
 - Recording Resolution: 5M/4M/3M/1080P/960P/720P, etc (All Real Time)
 - HD Output/VGA Output: 1920×1080/1280×1024/1280×720
 - Audio Output: 1CH 3.5mm Headphone Socket
 - Interface: 1xRJ-45 10/100Mbps Self-adaptive Ethernet Interface, 2xUSB2.0
 - Storage: 1xSATA (MAX 8TB HDD)
 - Power Input: 12V/2000mA
 - Dimension(W×D×H): 260*215*43(mm)



- Model:**
NVR3616D
- Key Features:**
- IP Camera Input: 16CH (5M, 3M, 2M, 1.3M, 1M, etc)
 - Compression Method: H.265/H.265+, H.264/H.264+
 - Recording Resolution: 5M/4M/3M/1080P/960P/720P, etc (All Real Time)
 - HD Output/VGA Output: 1920×1080/1280×1024/1280×720
 - Audio Output: 1CH 3.5mm Headphone Socket
 - Interface: 1xRJ-45 10/100Mbps Self-adaptive Ethernet Interface, 2xUSB2.0
 - Storage: 1xSATA (MAX 8TB HDD)
 - Power Input: DC12V/2000mA
 - Dimension(W×D×H): 260*215*43(mm)



- Model:**
NVR3609PG
- Key Features:**
- IP Camera Input: 9CH (5M, 3M, 2M, 1.3M, 1M, etc)
 - Compression Method: H.265/H.265+, H.264/H.264+
 - Recording Resolution: 5M/4M/3M/1080P/960P/720P, etc (All Real Time)
 - HD Output/VGA Output: 1920×1080/1280×1024/1280×720
 - Audio Output: 1CH 3.5mm Headphone Socket
 - Interface: 1xRJ-45 10/100Mbps Self-adaptive Ethernet Interface, 2xUSB2.0
 - Storage: 1xSATA (MAX 8TB HDD)
 - Power Input: 12V/2000mA
 - Dimension(W×D×H): 219*217*40(mm)



- Model:**
NVR3616PG
- Key Features:**
- IP Camera Input: 16CH (5M, 3M, 2M, 1.3M, 1M, etc)
 - Compression Method: H.265/H.265+, H.264/H.264+
 - Recording Resolution: 5M/4M/3M/1080P/960P/720P, etc (All Real Time)
 - HD Output/VGA Output: 1920×1080/1280×1024/1280×720
 - Audio Output: 1CH 3.5mm Headphone Socket
 - Interface: 1xRJ-45 10/100Mbps Self-adaptive Ethernet Interface, 2xUSB2.0
 - Storage: 1xSATA (MAX 8TB HDD)
 - Power Input: 12V/2000mA
 - Dimension(W×D×H): 219*217*40(mm)

12MP/4K H.265+ NVR



- Model:**
NVR3625DB
- Key Features:**
- IP Camera Input: 25CH (8M/5M/4M/3M/2M/1M, etc)
 - POE: 8 x Independent 100Mbps PoE Network Interfaces (Total Power Output ≥ 100W)
 - Compression Method: H.265/H.265+, H.264/H.264+
 - Recording Resolution: 8M/5M/4M/3M/1080P/960P/720P, etc (All Real Time)
 - HD Output/VGA Output: 8M (3840×2160/1920×1080/1280×1024/1280×720)
 - Interface: 1xRJ-45 10/100/1000Mbps Self-adaptive Ethernet Interface, 1xUSB2.0 & 1xUSB3.0
 - Storage: 2xSATA (MAX 16TB HDD)
 - Power Input: DC12V/2000mA
 - Dimension(W×D×H): 310*295*46(mm)



- Model:**
NVR3636DB
- Key Features:**
- IP Camera Input: 36CH (12MP/8M/5MP/3MP/2MP/1MP, etc)
 - Compression Method: H.265/H.265+, H.264/H.264+
 - Recording Resolution: 12M/8M/5M/4M/3M/1080P/960P/720P, etc (All Real Time)
 - HD Output/VGA Output: 8M (3840×2160/1920×1080/1280×1024/1280×720)
 - Interface: 1xRJ-45 10/100/1000Mbps Self-adaptive Ethernet Interface, 1xUSB2.0 & 1xUSB3.0
 - Storage: 2xSATA (MAX 16TB HDD)
 - Power Input: DC12V/2000mA
 - Dimension(W×D×H): 310*295*46(mm)



- Model:**
NVR3664L
- Key Features:**
- IP Camera Input: 64CH (12MP/8M/5MP/3MP/2MP/1MP, etc)
 - Compression Method: H.265/H.265+, H.264/H.264+
 - Recording Resolution: 12M/8M/5M/4M/3M/1080P/960P/720P, etc (All Real Time)
 - HD Output/VGA Output: 8M (3840×2160/1920×1080/1280×1024/1280×720)
 - Interface: 2xRJ-45 10/100/1000Mbps Self-adaptive Ethernet Interface, 1xUSB2.0 & 1xUSB3.0
 - Storage: 8xSATA (MAX 48TB HDD) + 1xE-SATA (MAX 8TB HDD)
 - Power Input: DC12V/2000mA
 - Dimension(W×D×H): 440*450*95(mm)

NVR

NVR

8CH H.265+/H.265 WIFI NVR



WIFI NVR

5-IN-1 4K-N AI XVR



XVR

1x SATA
H.265+



The NVR featured H.265+ is able to have lower video storage space occupation and maintain low bit rate but same image quality.



- Model:** NVR3608DW
Key Features:
- Camera Input: 9CH 1080P@30fps/9CH 3MP@15fps/4CH 5MP@30fps Wi-Fi IP Camera
 - Compression Method: H.265/H.265+, H.264/H.264+
 - WIFI Range: No Obstacles 300m Max.
 - Recording Resolution: 5M/4M/3M/1080P/960P/720p, etc (All Real Time)
 - HD Output/VGA Output: 1920 x 1080/1280 x 1024/1280 x 720
 - Interface: 1xRJ45, 1xUSB2.0
 - Storage: 1xSATA (MAX 6TB HDD)
 - Power Input: 12V/2000MA
 - Dimension(W x D x H) :260*215*43(mm)

2x SATA
H.265+



- Model:** iXVRDA3116HDB
Key Features:
- Video Input: 16HD + 8IPC, 25CH/HD + IPC, 32CH/IPC (HD include AHD, TVI, CVI)
 - Recording resolution: 4K-N@8fps, 5M-N@10fps, 5M@6fps, 4M-N@15fps, 4M@8fps, 3M-N@18fps, 3M@9fps, 2M@15fps
 - Playback: IPC Only 9CH /HD Only 16CH : 4 *1080P
 - 1xRS485, 2 x USB, 1xRJ45(10M/100M/1000M adaptive Ethernet interface)
 - AI Management: AI Detection/ Face Comparison: 4CH
 - 16 Face Database: Store 254 pictures/database, totally up to 4064 pictures
 - Power consumption: DC 12V5A ≤ 10W (Without Hard Disk)
 - 2 *SATA (3.5" SATA, Up to 12TB)
 - Dimensions (L x W x H): 310*295*46(mm)



Face Recognition



Face Comparison

5-IN-1 5M-N H.265+ XVR

1x SATA
H.265+



P2P



5M-N **H.265+** **Smart Phone** **VMS** **USB** **DDNS** **P2P** **SERIAL SATA**

Model: XVRA2004D

Key Features:

- Video Input: 4CH/HD, 6CH/HD + IPC, 9CH/IPC (HD include AHD, TVI, CVI)
- Video Output: 1xHD Output@1920*1080P; 1xVGA@1920*1080P
- Compression Method: H.265/H.264
- Recording resolution: 5M-N@8fps/4M-N@15fps/ 3M-N@18fps/2M-N@18fps
- Playback: IPC Only 4CH/HD Only 4 CH : 2*1080P/1*5M
- 1xRS485, 2 x USB, 1xRJ45(10M/100M adaptive Ethernet interface)
- AI Management: AI detection/ Face Comparison: 1CH
- Backup:Regular backup, smart backup
- Power consumption: DC 12V/2A ≤ 4W (Without Hard Disk)
- 1*SATA (2.5"/3.5" SATA, Up to 6TB)
- Dimensions (L x W x H): 260*215*43(mm)

1x SATA
H.265+



P2P



5M-N **H.265+** **Smart Phone** **VMS** **USB** **DDNS** **P2P** **SERIAL SATA**

Model: XVRDA2008D

Key Features:

- Video Input: 8CH/HD, 9CH/HD + IPC, 16CH/IPC (HD include AHD, TVI, CVI)
- Video Output: 1xHD Output@1920*1080P; 1xVGA@1920*1080P
- Compression Method: H.265 + /H.264 +
- Recording resolution: 5M-N@6fps/4M-N@8fps/ 3M-N@10fps/ 2M-N@15fps
- Playback: IPC Only 4CH/HD Only 8 CH : 2*1080P/1*5M
- 1xRS485, 2 x USB, 1xRJ45(10M/100M adaptive Ethernet interface)
- AI Management: AI detection/ Face Comparison: 1CH
- Backup:Regular backup, smart backup
- Power consumption: DC 12V/2A ≤ 6W (Without Hard Disk)
- 1*SATA (2.5"/3.5" SATA, Up to 6TB)
- Dimensions (L x W x H): 260*215*43(mm)

1x SATA
H.265+



P2P



5M-N **H.265+** **Smart Phone** **VMS** **USB** **DDNS** **P2P** **SERIAL SATA**

Model: XVRDA2116D

Key Features:

- Video Input: 16CH/HD, 16CH/HD + IPC, 16CH/IPC (HD include AHD, TVI, CVI)
- Video Output: 1xHD Output@2K(2560x1440); 1xVGA@1920*1080P
- Compression Method: H.265 + /H.264 +
- Recording resolution: 5M-N@6fps/4M-N@8fps/ 3M-N@10fps/ 2M-N@15fps
- Playback: IPC Only 4CH/HD Only 16CH : 4*1080P
- 1xRS485, 2 x USB, 1xRJ45(10M/100M adaptive Ethernet interface)
- AI Management: AI detection/ Face Comparison: 2CH
- Backup:Regular backup, smart backup
- Power consumption: DC 12V/2A ≤ 6W (Without Hard Disk)
- 1*SATA (2.5"/3.5" SATA, Up to 6TB)
- Dimensions (L x W x H): 260*215*43(mm)

2x SATA
H.265+



P2P



5M-N **H.265+** **Smart Phone** **VMS** **USB** **DDNS** **P2P** **SERIAL SATA**

Model: XVRDA2116DB

Key Features:

- Video Input: 8CH/HD, 9CH/HD + IPC, 16CH/IPC (HD include AHD, TVI, CVI)
- Video Output: 1xHD Output@1920*1080P; 1xVGA@1920*1080P
- Compression Method: H.265 + /H.264 +
- Recording resolution: 5M-N@6fps/4M-N@8fps/ 3M-N@10fps/ 2M-N@15fps
- Playback: IPC Only 4CH/HD Only 8 CH : 2*1080P/1*5M
- 1xRS485, 2 x USB, 1xRJ45(10M/100M adaptive Ethernet interface)
- AI Management: AI detection/ Face Comparison: 1CH
- Backup:Regular backup, smart backup
- Power consumption: DC 12V/2A ≤ 6W (Without Hard Disk)
- 2*SATA (3.5" SATA, Up to 12TB)
- Dimensions (L x W x H): 310*295*46(mm)

5-IN-1 4K-N H.265+ XVR

1x SATA
H.265+



P2P



4K-N **H.265+** **Smart Phone** **VMS** **USB** **DDNS** **P2P** **SERIAL SATA**

Model: XVRDA2004HD

Key Features:

- Video Input: 4HD + 2IPC, 9CH/HD + IPC, 16CH/IPC (HD include AHD, TVI, CVI)
- Video Output: 1xHD Output@1920*1080P; 1xVGA@1920*1080P
- Compression Method: H.265 + /H.264 +
- Recording resolution: 4K-N@8fps, 5M-N@10fps, 5M@6fps, 4M-N@15fps, 4M@8fps, 3M-N@18fps, 3M@9fps, 2M@15fps
- Playback: IPC Only 4CH/HD Only 4CH : 4*5M@6fps/1*5M@30fps
- 1xRS485, 2 x USB, 1xRJ45(10M/100M adaptive Ethernet interface)
- AI Management: AI detection/ Face Comparison: 1CH
- Backup:Regular backup, smart backup
- Power consumption: DC 12V/2A ≤ 6W (Without Hard Disk)
- 1*SATA (2.5"/3.5" SATA, Up to 6TB)
- Dimensions (L x W x H): 260*215*43(mm)

1x SATA
H.265+



P2P



4K-N **H.265+** **Smart Phone** **VMS** **USB** **DDNS** **P2P** **SERIAL SATA**

Model: XVRDA2108HD

Key Features:

- Video Input: 8HD + 4IPC, 14CH/HD + IPC, 16CH/IPC (HD include AHD, TVI, CVI)
- Video Output: 1xHD Output@3840*2160P; 1xVGA@1920*1080P
- Compression Method: H.265 + /H.264 +
- Recording resolution: 4K-N@8fps, 5M-N@10fps, 5M@6fps, 4M-N@15fps, 4M@8fps, 3M-N@18fps, 3M@9fps, 2M@15fps
- Playback: IPC Only 4CH/HD Only 8CH : 2*1080P/1*5M
- 1xRS485, 2 x USB, 1xRJ45(10M/100M adaptive Ethernet interface)
- AI Management: AI detection/ Face Comparison: 2CH
- Backup:Regular backup, smart backup
- Power consumption: DC 12V/2A ≤ 6W (Without Hard Disk)
- 1*SATA (2.5"/3.5" SATA, Up to 6TB)
- Dimensions (L x W x H): 260*215*43(mm)

1x SATA
H.265+



P2P



4K-N **H.265+** **Smart Phone** **VMS** **USB** **DDNS** **P2P** **SERIAL SATA**

Model: XVRDA3116HD

Key Features:

- Video Input: 16HD + 8IPC, 25CH/HD + IPC, 32CH/IPC (HD include AHD, TVI, CVI)
- Video Output: 1xHD Output@3840*2160P; 1xVGA@1920*1080P
- Compression Method: H.265 + /H.264 +
- Recording resolution: 4K-N@8fps, 5M-N@10fps, 5M@6fps, 4M-N@15fps, 4M@8fps, 3M-N@18fps, 3M@9fps, 2M@15fps
- Playback: IPC Only 9CH/HD Only 16CH : 4*1080P
- 1xRS485, 2 x USB, 1xRJ45(10M/100M adaptive Ethernet interface)
- AI Management: AI detection/ Face Comparison: 4CH
- Backup:Regular backup, smart backup
- Power consumption: DC 12V/2A ≤ 10W (Without Hard Disk)
- 1*SATA (2.5"/3.5" SATA, Up to 6TB)
- Dimensions (L x W x H): 260*215*43(mm)

5-IN-1 4K-N H.265+ XVR

2x SATA
H.265+



16CH



Model: XVRDA3116HDB

Key Features:

- Video Input: 16HD + 8IPC, 25CH/HD + IPC, 32CH/IPC (HD include AHD, TVI, CVI)
- Video Output: 1xHD Output@3840*2160P; 1xVGA@1920*1080P
- Compression Method: H.265+ /H.264+
- Recording resolution: 4K-N@8fps, 5M-N@10fps, 5M@6fps, 4M-N@15fps, 4M@8fps, 3M-N@18fps, 3M@9fps, 2M@15fps
- Playback: IPC Only 9CH /HD Only 16CH : 4 * 1080P
- 1xRS485, 2 × USB, 1xRJ45(10M/100M adaptive Ethernet interface)
- AI Management: AI detection/ Face Comparison: 4CH
- Backup: Regular backup, smart backup
- Power consumption: DC 12V/2A ≤ 10W (Without Hard Disk)
- 2 * SATA (2.5"/3.5" SATA, Up to 12TB)
- Dimensions (L × W × H): 310*295*46(mm)

5-IN-1 5M H.265+ XVR

1x SATA
H.265+



4CH



Model: XVRDA2104D

Key Features:

- Video Input: 4HD + 4IPC, 9CH/HD + IPC, 16CH/IPC (HD include AHD, TVI, CVI)
- Video Output: 1xHD Output@3840*2160P; 1xVGA@1920*1080P
- Compression Method: H.265+ /H.264+
- Recording resolution: HD: 8M@8fps; 5M@12fps; 4M@15fps; 3M@18fps; 1080P/720P, PAL@25fps/NTSC@30fps; Analog: 960H, PAL@25fps/NTSC@30fps; IPC Only: 8MP/6MP/5MP/4MP/3MP/2MP/1MP, etc (Total incoming bandwidth ≤ 80M)
- Preview resolution: 8M/5M/4M/3M/1080P/720P
- Playback: Support HD camera 1/4CH@main stream
- 1xRS485, 2 × USB, 1xRJ45(10M/100M adaptive Ethernet interface)
- AI Management: AI detection/ Face Comparison: 2CH
- Backup: USB2.0 (such as U disk, USB Drive) and network
- Power consumption: DC 12V/2A ≤ 6W (Without Hard Disk)
- 1 * SATA (2.5"/3.5" SATA, Up to 8TB)
- Dimensions (L × W × H): 260*215*43(mm)

4x SATA
H.265+



16CH



Model: XVRDA3116HK

Key Features:

- Video Input: 16HD + 8IPC, 25CH/HD + IPC, 32CH/IPC (HD include AHD, TVI, CVI)
- Video Output: 1xHD Output@3840*2160P; 1xVGA@1920*1080P
- Compression Method: H.265+ /H.264+
- Recording resolution: 4K-N@8fps, 5M-N@10fps, 5M@6fps, 4M-N@15fps, 4M@8fps, 3M-N@18fps, 3M@9fps, 2M@15fps
- Playback: IPC Only 9CH /HD Only 16CH
- 1xRS485, 2 × USB, 1xRJ45(10M/100M/1000M adaptive Ethernet interface)
- AI Management: AI detection/ Face Comparison: 4CH
- Backup: USB2.0 (such as U disk, USB Drive) and network
- Power consumption: AC 115V ~ 230V/3A ≤ 10W (Without Hard Disk)
- 4 * SATA (2.5"/3.5" SATA, Up to 32TB)
- Dimensions (L × W × H): 439*367*69(mm)

1x SATA
H.265+



8CH



Model: XVRDA3108D

Key Features:

- Video Input: 8HD + 8IPC, 16CH/HD + IPC, 32CH/IPC (HD include AHD, TVI, CVI)
- Video Output: 1xHD Output@3840*2160P; 1xVGA@1920*1080P
- Compression Method: H.265+ /H.264+
- Recording resolution: HD: 8M@8fps; 5M@12fps; 4M@15fps; 3M@18fps; 1080P/720P@30fps; Analog: 960H, PAL@25fps/NTSC@30fps; IPC Only: 8MP/6MP/5MP/4MP/3MP/2MP/1MP, etc (Total incoming bandwidth ≤ 160M)
- Preview resolution: 8M/5M/4M/3M/1080P/720P
- Playback: IPC Only 9CH /HD Only 8CH
- 1xRS485, 2 × USB, 1xRJ45(10M/100M adaptive Ethernet interface)
- AI Management: AI detection/ Face Comparison: 4CH
- Backup: USB2.0 (such as U disk, USB Drive) and network
- Power consumption: DC 12V/2A ≤ 10W (Without Hard Disk)
- 1 * SATA (2.5"/3.5" SATA, Up to 8TB)
- Dimensions (L × W × H): 260*215*43(mm)

8x SATA 1x E-SATA
H.265+



32CH



Model: XVRDA3132HL

Key Features:

- Video Input: 32CH/HD, 32CH/HD + IPC, 32CH/IPC (HD include AHD, TVI, CVI)
- Video Output: 1xHD Output@3840*2160P; 1xVGA@1920*1080P
- Compression Method: H.265+ /H.264+
- Recording resolution: 4K-N@8fps, 5M-N@10fps, 5M@6fps, 4M-N@15fps, 4M@8fps, 3M-N@18fps, 3M@9fps, 2M@15fps
- Playback: IPC Only 9CH /HD Only 16CH
- 1xRS485, 2 × USB, 1xRJ45(10M/100M/1000M adaptive Ethernet interface)
- Backup: USB2.0 (such as U disk, USB Drive) and network
- Backup: Regular backup, smart backup
- Power consumption: AC 115V ~ 230V/3A ≤ 10W (Without Hard Disk)
- 8 SATA Hard Disk Interface (2.5"/3.5" SATA, Up to 64TB)
- Dimensions (L × W × H): 440*450*95(mm)

2x SATA
H.265+



8CH



Model: XVRDA3108DB

Key Features:

- Video Input: 8HD + 8IPC, 16CH/HD + IPC, 32CH/IPC (HD include AHD, TVI, CVI)
- Video Output: 1xHD Output@3840*2160P; 1xVGA@1920*1080P
- Compression Method: H.265+ /H.264+
- Recording resolution: HD: 8M@8fps; 5M@12fps; 4M@15fps; 3M@18fps; 1080P/720P, PAL@25fps/NTSC@30fps; Analog: 960H, PAL@25fps/NTSC@30fps; IPC Only: 8MP/6MP/5MP/4MP/3MP/2MP/1MP, etc (Total incoming bandwidth ≤ 160M)
- Preview resolution: 8M/5M/4M/3M/1080P/720P
- Playback: IPC Only 9CH /HD Only 8CH
- 1xRS485, 2 × USB, 1xRJ45(10M/100M/1000M adaptive Ethernet interface)
- AI Management: AI detection/ Face Comparison: 4CH
- Backup: USB2.0 (such as U disk, USB Drive) and network
- Power consumption: DC 12V/2A ≤ 6W (Without Hard Disk)
- 2 * SATA (2.5"/3.5" SATA, Up to 16TB)
- Dimensions (L × W × H): 310*295*46(mm)

5-IN-1 5M/4K H.265 XVR

2x SATA
H.265+



P2P



16CH



Model: XVRDA3116DB

Key Features:

- Video Input: 16CH/HD, 16CH/HD + IPC, 32CH/IPC (HD include AHD, TVI, CVI)
- Video Output: 1xHD Output@3840*2160P; 1xVGA@1920*1080P
- Compression Method: H.265 + /H.264 +
- Recording resolution: HD: 8M@8fps; 5M@12fps; 4M@15fps; 3M@18fps; 1080P/720P, PAL@25fps/NTSC@30fps; Analog: 960H, PAL@25fps/NTSC@30fps; IPC Only: 8MP/6MP/5MP/4MP/3MP/2MP/1MP, etc (Total incoming bandwidth ≤ 160M)
- Preview resolution: 8M/5M/4M/3M/1080P/720P
- Playback: IPC Only 9CH /HD Only 8CH
- 1xRS485, 2 × USB, 1xRJ45(10M/100M/1000M adaptive Ethernet interface)
- Backup: USB2.0 (such as U disk, USB drive) and Network
- Power consumption: DC 12V/4A ≤ 10W (Without Hard Disk)
- 2*SATA (2.5"/3.5" SATA, Up to 16TB)
- Dimensions (L × W × H): 310*295*46(mm)

8x SATA
H.265+



P2P



16CH



Model: XVRDA3116L

Key Features:

- Video Input: 16CH/HD, 16CH/HD + IPC, 32CH/IPC (HD include AHD, TVI, CVI)
- Video Output: 1xHD Output@3840*2160P; 1xVGA@1920*1080P
- Compression Method: H.265 + /H.264 +
- Recording resolution: HD: 8M@8fps; 5M@12fps; 4M@15fps; 3M@18fps; 1080P/720P, PAL@25fps/NTSC@30fps; Analog: 960H, PAL@25fps/NTSC@30fps; IPC Only: 8MP/6MP/5MP/4MP/3MP/2MP/1MP, etc (Total incoming bandwidth ≤ 160M)
- Preview resolution: 8M/5M/4M/3M/1080P/720P
- Playback: IPC Only 9CH /HD Only 8CH
- 1xRS485, 2 × USB, 1xRJ45(10M/100M/1000M adaptive Ethernet interface)
- Backup: USB2.0 (such as U disk, USB drive) and Network
- Power consumption: AC115/230V 3A ≤ 10W (Without Hard Disk)
- 8*SATA (2.5"/3.5" SATA, Up to 64TB)
- Dimensions (L × W × H): 440*450*95(mm)

2x SATA
H.265+



P2P



4CH



Model: XVRDKA3104DB

Key Features:

- Video Input: 4HD + 8IPC, 16CH/HD + IPC, 32CH/IPC (HD include AHD, TVI, CVI)
- Video Output: 1xHD Output@3840*2160P; 1xVGA@1920*1080P
- Compression Method: H.265 + /H.264 +
- Recording resolution: HD: 8M@15fps; 5M, PAL@12.5fps/NTSC@20fps; 4M, PAL@25fps/NTSC@30fps; 3M, PAL@25fps/NTSC@30fps; 1080P/720P, PAL@25fps/NTSC@30fps; Analog: 960H, PAL@25fps/NTSC@30fps; IPC Only: 8MP/6MP/5MP/4MP/3MP/2MP/1MP, etc (Total incoming bandwidth ≤ 160M)
- Preview resolution: 8M/5M/4M/3M/1080P/720P
- Playback: IPC Only 9CH /HD Only 4CH
- 1xRS485, 2 × USB, 1xRJ45(10M/100M/1000M adaptive Ethernet interface)
- AI Management: AI detection/ Face Comparison: 4CH
- Backup: USB2.0 (such as U disk, USB drive) and Network
- Power consumption: DC 12V/4A ≤ 10W (Without Hard Disk)
- 2*SATA (2.5"/3.5" SATA, Up to 16TB)
- Dimensions (L × W × H): 310*295*46(mm)

1x SATA
H.265+



P2P



8CH



Model: XVRDKA3108DB

Key Features:

- Video Input: 8CH/HD, 16CH/HD + IPC, 32CH/IPC (HD include AHD, TVI, CVI)
- Video Output: 1xHD Output@3840*2160P; 1xVGA@1920*1080P
- Compression Method: H.265 + /H.264 +
- Recording resolution: 8M@15fps; 5M, PAL@12.5fps/NTSC@20fps; 4M, PAL@25fps/NTSC@30fps; 3M, PAL@25fps/NTSC@30fps; 1080P/720P, PAL@25fps/NTSC@30fps; Analog: 960H, PAL@25fps/NTSC@30fps; IPC Only: 8MP/6MP/5MP/4MP/3MP/2MP/1MP, etc (Total incoming bandwidth ≤ 160M)
- Preview resolution: 8M/5M/4M/3M/1080P/720P
- Playback: IPC Only 9CH /HD Only 8CH
- 1xRS485, 2 × USB, 1xRJ45(10M/100M adaptive Ethernet interface)
- Backup: USB2.0 (such as U disk, USB drive) and Network
- Power consumption: DC 12V/4A ≤ 10W (Without Hard Disk)
- 2*SATA (2.5"/3.5" SATA, Up to 16TB)
- Dimensions (L × W × H): 310*295*46(mm)

4MP H.265+ SDI

1x SATA
H.265+



P2P



4CH



Model: SDIA2104D

DIY Video Input:

- SDI: Max 4CH@60fps
- IP: Max 16CH@30fps

Recording resolution and frame rate:

- SDI: 4M, PAL@15fps/NTSC@15fps; 1080P, PAL@25fps/NTSC@30fps;
- IP: 8M/5MP/4M/1080P/960P/720P (Total incoming bandwidth ≤ 80M), PAL@25fps/NTSC@30fps;

Key Features:

- Compression Method: H.265/H.265+, H.264/H.264+
- Audio Input/Output: RCA 4CH In/ 1CH Out
- Interface: 1xRS485, 2xUSB, 1xRJ45(10M/100M adaptive Ethernet interface)
- Storage: 1xSATA (MAX 8TB HDD)
- Power Input: DC 12V ≤ 4W (Without Hard Disk)
- Dimension(W × D × H): 260*215*43(mm)

2x SATA
H.265+



P2P



8CH



Model: SDIA3108DB

DIY Video Input:

- SDI: Max 8CH@60fps
- IP: Max 32CH@30fps

Recording resolution and frame rate:

- SDI: 4M, PAL@15fps/NTSC@15fps; 1080P, PAL@25fps/NTSC@30fps;
- IP: 8M/6M/5M/4M/1080P/960P/720P (Total incoming bandwidth ≤ 160M), PAL@25fps/NTSC@30fps;

Key Features:

- Compression Method: H.265/H.265+, H.264/H.264+
- Audio Input/Output: RCA 4CH In/ 1CH Out
- Interface: 1xRS485, 2xUSB, 1xRJ45(10M/100M adaptive Ethernet interface)
- Storage: 2xSATA (MAX 16TB HDD)
- Power Input: DC 12V ≤ 6W (Without Hard Disk)
- Dimension(W × D × H): 310*295*46(mm)

2x SATA
H.265+



P2P



8CH



Model: SDIA3116DB

DIY Video Input:

- SDI: Max 16CH@60fps
- IP: Max 32CH@30fps

Recording resolution and frame rate:

- SDI: 4M, PAL@15fps/NTSC@15fps; 1080P, PAL@25fps/NTSC@30fps;
- IP: 8M/6M/5M/4M/1080P/960P/720P (Total incoming bandwidth ≤ 160M), PAL@25fps/NTSC@30fps;

Key Features:

- Compression Method: H.265/H.265+, H.264/H.264+
- Audio Input/Output: RCA 6CH In/ 1CH Out
- Alarm Input/Output: Alarm 4CH In/ 1CH Out
- Interface: 1xRS485, 2xUSB, 1xRJ45(10M/100M/1000M adaptive Ethernet interface)
- Storage: 2xSATA (MAX 16TB HDD)
- Power Input: DC 12V ≤ 8W (Without Hard Disk)
- Dimension(W × D × H): 310*295*46(mm)



DIY KITS

Wireless Kits

POE NVR Kits

XVR Kits

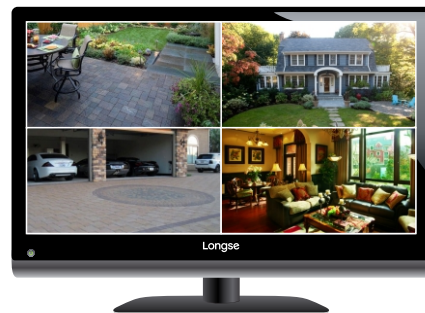

LCD All in One Wi-Fi Kits

WiFi 2MP H.265+ Plug and Play



Model: WiFi3604M4SW200

Specification

- 12 Inch Monitor
- Camera Input: 4CH 1080P@15fps Wi-Fi IP Camera (Max. 4CH Input)
- IP Camera LBH30SW200W: 2MP Hisilicon, Outdoor Metal Bullet Case,
- 25m Night Vision, Support Wi-Fi
- Video Output: 1xHD Output/ 1xVGA Output
- Compression Method: H.265/H.265+, H.264/H.264+
- Recording Resolution: 1920*1080
- Wi-Fi Range: No Obstacles 300m Max.
- Network Interface: 1xRJ45 (10M/100M Adaptive Ethernet Interface)
- Preview Resolution: 4CH@1080P
- Playback Resolution: 4CH@1080P
- Hexaplex Operation Simultaneously: Preview, Recording, Playback, Live, Backup
- Static, Dynamic IP and DDNS, P2P, Wi-Fi, Support IE and Special Client Software
- Backup: 1xUSB2.0 (such as U Disk, USB Drive) and Network
- Support Remote View by Smart Phone
- Power Adaptor: 1xDC12V2A for Wi-Fi NVR, 4xDC12V0.5A for Wi-Fi IP Camera

What's Inside

LCD NVR	1
Megapixel IP Camera	4
USB Mouse	1
Power Supply DC12V/2A	1
Power Supply DC12V/0.5A	4
User Manual	1
1m Net Cable	1

WiFi 5MP H.265+ Plug and Play



Model: WiFi3604M4FK500

Specification

- 12 Inch Monitor
- Camera Input: 4CH 5MP@15fps Wi-Fi IP Camera (Max. 4CH Input)
- IP Camera LBF30FK500W: 5MP, Outdoor Metal Bullet Case,
- 25m Night Vision, Support Wi-Fi
- Video Output: 1xHD Output/ 1xVGA Output
- Compression Method: H.265/H.265+, H.264/H.264+
- Recording Resolution: 2592*1944
- Wi-Fi Range: No Obstacles 300m Max.
- Network Interface: 1xRJ45 (10M/100M Adaptive Ethernet Interface)
- Preview Resolution: 4CH@1440*1080
- Playback Resolution: 1CH@2592*1944
- Hexaplex Operation Simultaneously: Preview, Recording, Playback, Live, Backup
- Static, Dynamic IP and DDNS, P2P, Wi-Fi, Support IE and Special Client Software
- Backup: 1xUSB2.0 (such as U Disk, USB Drive) and Network
- Support Remote View by Smart Phone
- Power Adaptor: 1xDC12V2A for Wi-Fi NVR, 4xDC12V0.5A for Wi-Fi IP Camera

What's Inside

LCD NVR	1
Megapixel IP Camera	4
USB Mouse	1
Power Supply DC12V/2A	1
Power Supply DC12V/0.5A	4
User Manual	1
1m Net Cable	1

2CH H.265+ WIFI Kits

Wireless Kits

WiFi **2MP** **H.265+** 



Model: WIFI3608PGE2SW200/WIFI3608PGED2SW200

Specification

- Camera Input: 2CH 1080P@15fps Wi-Fi IP Camera (Max. 9CH Input)
- IP Camera LBH30SW200W: 2MP Hisilicon, Outdoor Metal Bullet Case,
- 25m Night Vision, Support Wi-Fi
- Video Output: 1xHD Output/ 1xVGA Output
- Compression Method: H.265/H.265+, H.264/H.264+
- Recording Resolution: 1920*1080
- Wi-Fi Range: No Obstacles 300m Max.
- Network Interface: 1xRJ45 (10M/100M Adaptive Ethernet Interface)
- Preview Resolution: 4CH@1080P; 9CH@D1
- Playback Resolution: 4CH@1080P
- Hexaplex Operation Simultaneously: Preview, Recording, Playback, Live, Backup
- Static, Dynamic IP and DDNS, P2P, Wi-Fi, Support IE and Special Client Software
- Backup: 1xUSB2.0 (such as U Disk, USB Drive) and Network
- Support Remote View by Smart Phone
- Power Adaptor: 1xDC12V2A for Wi-Fi NVR, 2xDC12V0.5A for Wi-Fi IP Camera
- Dimensions of NVR (L x W x H): 219*217*40(mm)
- Weight of Package: 4.6kg

What's Inside

NVR	1
Megapixel IP Camera	2
USB Mouse	1
Power Supply DC12V/2A	1
Power Supply DC12V/0.5A	2
User Manual	1
1m Net Cable	1
2TB hard disk (Optional)	1

4CH H.265+ WIFI Kits

Wireless Kits

WiFi **2MP** **H.265+** 



Model: WIFI3608PGE4SW200/WIFI3608PGED4SW200

Specification

- Camera Input: 4CH 1080P@15fps Wi-Fi IP Camera (Max. 9CH Input)
- IP Camera LBH30SW200W: 2MP Hisilicon, Outdoor Metal Bullet Case,
- 25m Night Vision, Support Wi-Fi
- Video Output: 1xHD Output/ 1xVGA Output
- Compression Method: H.265/H.265+, H.264/H.264+
- Recording Resolution: 1920*1080
- Wi-Fi Range: No Obstacles 300m Max.
- Network Interface: 1xRJ45 (10M/100M Adaptive Ethernet Interface)
- Preview Resolution: 4CH@1080P; 9CH@D1
- Playback Resolution: 4CH@1080P
- Hexaplex Operation Simultaneously: Preview, Recording, Playback, Live, Backup
- Static, Dynamic IP and DDNS, P2P, Wi-Fi, Support IE and Special Client Software
- Backup: 1xUSB2.0 (such as U Disk, USB Drive) and Network
- Support Remote View by Smart Phone
- Power Adaptor: 1xDC12V2A for Wi-Fi NVR, 4xDC12V0.5A for Wi-Fi IP Camera
- Dimensions of NVR (L x W x H): 219*217*40(mm)
- Weight of Package: 5.3kg

What's Inside

NVR	1
Megapixel IP Camera	4
USB Mouse	1
Power Supply DC12V/2A	1
Power Supply DC12V/0.5A	4
User Manual	1
1m Net Cable	1
2TB hard disk (Optional)	1

WiFi **2MP** **H.265+** 



Model: WIFI3608DE2SW200/WIFI3608DED2SW200

Specification

- Camera Input: 2CH 1080P@15fps Wi-Fi IP Camera (Max. 9CH Input)
- IP Camera LBH30SW200W: 2MP Hisilicon, Outdoor Metal Bullet Case,
- 25m Night Vision, Support Wi-Fi
- Video Output: 1xHD Output/ 1xVGA Output
- Compression Method: H.265/H.265+, H.264/H.264+
- Recording Resolution: 1920*1080
- Wi-Fi Range: No Obstacles 350m Max.
- Network Interface: 1xRJ45 (10M/100M Adaptive Ethernet Interface)
- Preview Resolution: 4CH@1080P; 9CH@D1
- Playback Resolution: 4CH@1080P
- Hexaplex Operation Simultaneously: Preview, Recording, Playback, Live, Backup
- Static, Dynamic IP and DDNS, P2P, Wi-Fi, Support IE and Special Client Software
- Backup: 1xUSB2.0 (such as U Disk, USB Drive) and Network
- Support Remote View by Smart Phone
- Power Adaptor: 1xDC12V2A for Wi-Fi NVR, 2xDC12V0.5A for Wi-Fi IP Camera
- Dimensions of NVR (L x W x H): 260*215*43(mm)
- Weight of Package: 4.6kg

What's Inside

NVR	1
Megapixel IP Camera	2
USB Mouse	1
Power Supply DC12V/2A	1
Power Supply DC12V/0.5A	2
User Manual	1
1m Net Cable	1
2TB hard disk (Optional)	1

WiFi **2MP** **H.265+** 



Model: WIFI3608DE4SW200/WIFI3608DED4SW200

Specification

- Camera Input: 4CH 1080P@15fps Wi-Fi IP Camera (Max. 9CH Input)
- IP Camera LBH30SW200W: 2MP Hisilicon, Outdoor Metal Bullet Case,
- 25m Night Vision, Support Wi-Fi
- Video Output: 1xHD Output/ 1xVGA Output
- Compression Method: H.265/H.265+, H.264/H.264+
- Recording Resolution: 1920*1080
- Wi-Fi Range: No Obstacles 350m Max.
- Network Interface: 1xRJ45 (10M/100M Adaptive Ethernet Interface)
- Preview Resolution: 4CH@1080P; 9CH@D1
- Playback Resolution: 4CH@1080P
- Hexaplex Operation Simultaneously: Preview, Recording, Playback, Live, Backup
- Static, Dynamic IP and DDNS, P2P, Wi-Fi, Support IE and Special Client Software
- Backup: 1xUSB2.0 (such as U Disk, USB Drive) and Network
- Support Remote View by Smart Phone
- Power Adaptor: 1xDC12V2A for Wi-Fi NVR, 2xDC12V0.5A for Wi-Fi IP Camera
- Dimensions of NVR (L x W x H): 260*215*43(mm)
- Weight of Package: 5.3kg

What's Inside

NVR	1
Megapixel IP Camera	4
USB Mouse	1
Power Supply DC12V/2A	1
Power Supply DC12V/0.5A	4
User Manual	1
1m Net Cable	1
2TB hard disk (Optional)	1

4CH H.265+ WIFI Kits

WiFi 5MP H.265+ Plug and Play



Model: WIFI3604PGE4FK500

Specification

- Camera Input: 2CH 5M@15fps WiFi IP Camera (Max. 4CH Input)
- IP Camera LBH30SV500W: 5MP Hisilicon, Outdoor Metal Bullet Case, 30m Night Vision, Support WiFi & ONVIF
- Video Output: 1xHD Output/ 1xVGA Output
- Compression Method: H.265, H.264/H.264+
- Recording Resolution: 2592*1944
- WiFi Range: No Obstacles 300m Max.
- Network Interface: 1xRJ45 + 3xLAN (10M/100M Adaptive Ethernet Interface)
- Preview Resolution: 1CH@5M/4CH@1080P
- Playback Resolution: 1CH@5M
- Hexaplex Operation Simultaneously: Preview, Recording, Playback, Live, Backup
- Static, Dynamic IP and DDNS, P2P, WiFi, Support IE and Special Client Software
- 1 SATA Hard Disk, With 1x1TB Seagate Hard Disk ST1000VX005
- Backup: 2xUSB2.0 (such as U Disk, USB Drive) and Network
- Support Remote View by Smart Phone
- Power Adaptor: 1xDC12V2A for WiFi NVR, 2xDC12V0.5A for WiFi IP Camera
- Dimensions of NVR (L x W x H): 260*215*43(mm)
- Weight of Package: 4.6kg

What's Inside

NVR	1
Megapixel IP Camera	4
USB Mouse	1
Power Supply DC12V/2A	1
Power Supply DC12V/0.5A	4
User Manual	1
1m Net Cable	1
2TB hard disk (Optional)	1

4CH H.265+ WIFI Kits

WiFi 4K H.265+ Plug and Play



Model: WIFI3604PGE4FK800

Specification

- Camera Input: 4CH 8MP@15fps Wi-Fi IP Camera (Max. 4CH Input)
- IP Camera LBF30FK800W: 8MP, Outdoor Metal Bullet Case, 25m Night Vision, Support Wi-Fi
- Video Output: 1xHD Output/ 1xVGA Output
- Compression Method: H.265, H.264
- Recording Resolution: 3072*2592
- Wi-Fi Range: No Obstacles 300m Max.
- Network Interface: 1xRJ45 (10M/100M Adaptive Ethernet Interface)
- Preview Resolution: 4CH@1920*1080, 1CH@3072*2592
- Playback Resolution: 1CH@3072*2592
- Hexaplex Operation Simultaneously: Preview, Recording, Playback, Live, Backup
- Static, Dynamic IP and DDNS, P2P, Wi-Fi, Support IE and Special Client Software
- Backup: 1xUSB2.0 (such as U Disk, USB Drive) and Network
- Support Remote View by Smart Phone
- Power Adaptor: 1xDC12V2A for Wi-Fi NVR, 4xDC12V0.5A for Wi-Fi IP Camera
- Dimensions of NVR (L x W x H): 260*215*43(mm)
- Weight of Package: 5.3kg

What's Inside

NVR	1
Megapixel IP Camera	4
USB Mouse	1
Power Supply DC12V/2A	1
Power Supply DC12V/0.5A	4
User Manual	1
1m Net Cable	1
2TB hard disk (Optional)	1

WiFi 5MP H.265+ Plug and Play



Model: WIFI3604PGE4FK500

Specification

- Camera Input: 4CH 5MP@15fps Wi-Fi IP Camera (Max. 4CH Input)
- IP Camera LBF30FK500W: 5MP, Outdoor Metal Bullet Case, 25m Night Vision, Support Wi-Fi
- Video Output: 1xHD Output/ 1xVGA Output
- Compression Method: H.265/H.265+, H.264/H.264+
- Recording Resolution: 2592*1944
- Wi-Fi Range: No Obstacles 350m Max.
- Network Interface: 1xRJ45 (10M/100M Adaptive Ethernet Interface)
- Preview Resolution: 4CH@1440*1080, 1CH@2592*1944
- Playback Resolution: 1CH@2592*1944
- Hexaplex Operation Simultaneously: Preview, Recording, Playback, Live, Backup
- Static, Dynamic IP and DDNS, P2P, Wi-Fi, Support IE and Special Client Software
- Backup: 1xUSB2.0 (such as U Disk, USB Drive) and Network
- Support Remote View by Smart Phone
- Power Adaptor: 1xDC12V2A for Wi-Fi NVR, 4xDC12V0.5A for Wi-Fi IP Camera
- Dimensions of NVR (L x W x H): 260*215*43(mm)
- Weight of Package: 5.3kg

What's Inside

NVR	1
Megapixel IP Camera	4
USB Mouse	1
Power Supply DC12V/2A	1
Power Supply DC12V/0.5A	4
User Manual	1
1m Net Cable	1
2TB hard disk (Optional)	1

WiFi 4K H.265+ Plug and Play



Model: WIFI3604DE4FK800

Specification

- Camera Input: 4CH 8MP@15fps Wi-Fi IP Camera (Max. 4CH Input)
- IP Camera LBF30FK800W: 8MP, Outdoor Metal Bullet Case, 25m Night Vision, Support Wi-Fi
- Video Output: 1xHD Output/ 1xVGA Output
- Compression Method: H.265, H.264
- Recording Resolution: 3072*2592
- Wi-Fi Range: No Obstacles 350m Max.
- Network Interface: 1xRJ45 (10M/100M Adaptive Ethernet Interface)
- Preview Resolution: 4CH@1920*1080, 1CH@3072*2592
- Playback Resolution: 1CH@3072*2592
- Hexaplex Operation Simultaneously: Preview, Recording, Playback, Live, Backup
- Static, Dynamic IP and DDNS, P2P, Wi-Fi, Support IE and Special Client Software
- Backup: 1xUSB2.0 (such as U Disk, USB Drive) and Network
- Support Remote View by Smart Phone
- Power Adaptor: 1xDC12V2A for Wi-Fi NVR, 4xDC12V0.5A for Wi-Fi IP Camera
- Dimensions of NVR (L x W x H): 260*215*43(mm)
- Weight of Package: 5.3kg

What's Inside

NVR	1
Megapixel IP Camera	4
USB Mouse	1
Power Supply DC12V/2A	1
Power Supply DC12V/0.5A	4
User Manual	1
1m Net Cable	1
2TB hard disk (Optional)	1

Wireless Kits

Wireless Kits

6CH H.265+ WIFI Kits

WiFi 2MP H.265+



Model: WIFI3608PGE6SW200/WIFI3608PGED6SW200

Specification

- Camera Input: 6CH 1080P@15fps Wi-Fi IP Camera (Max. 9CH Input)
- IP Camera LBH30SW200W: 2MP Hisilicon, Outdoor Metal Bullet Case,
- 25m Night Vision, Support Wi-Fi
- Video Output: 1xHD Output/ 1xVGA Output
- Compression Method: H.265/H.265+, H.264/H.264+
- Recording Resolution: 1920*1080
- Wi-Fi Range: No Obstacles 300m Max.
- Network Interface: 1xRJ45 (10M/100M Adaptive Ethernet Interface)
- Preview Resolution: 4CH@1080P; 9CH@D1
- Playback Resolution: 4CH@1080P
- Hexaplex Operation Simultaneously: Preview, Recording, Playback, Live, Backup
- Static, Dynamic IP and DDNS, P2P, Wi-Fi, Support IE and Special Client Software
- Backup: 1xUSB2.0 (such as U Disk, USB Drive) and Network
- Support Remote View by Smart Phone
- Power Adaptor: 1xDC12V2A for Wi-Fi NVR, 2xDC12V0.5A for Wi-Fi IP Camera
- Dimensions of NVR (L x W x H): 219*217*40(mm)
- Weight of Package: 9.9kg

What's Inside

NVR	1
Megapixel IP Camera	6
USB Mouse	1
Power Supply DC12V/2A	1
Power Supply DC12V/0.5A	6
User Manual	1
1m Net Cable	1
2TB hard disk (Optional)	1

8CH H.265+ WIFI Kits

WiFi 2MP H.265+



Model: WIFI3608DE8SW200/WIFI3608PED8SW200

Specification

- Camera Input: 8CH 1080P@15fps Wi-Fi IP Camera (Max. 9CH Input)
- IP Camera LBH30SW200W: 2MP Hisilicon, Outdoor Metal Bullet Case,
- 25m Night Vision, Support Wi-Fi
- Video Output: 1xHD Output/ 1xVGA Output
- Compression Method: H.265/H.265+, H.264/H.264+
- Recording Resolution: 1920*1080
- Wi-Fi Range: No Obstacles 300m Max.
- Network Interface: 1xRJ45 (10M/100M Adaptive Ethernet Interface)
- Preview Resolution: 4CH@1080P; 9CH@D1
- Playback Resolution: 4CH@1080P
- Hexaplex Operation Simultaneously: Preview, Recording, Playback, Live, Backup
- Static, Dynamic IP and DDNS, P2P, Wi-Fi, Support IE and Special Client Software
- Backup: 1xUSB2.0 (such as U Disk, USB Drive) and Network
- Support Remote View by Smart Phone
- Power Adaptor: 1xDC12V2A for Wi-Fi NVR, 8xDC12V0.5A for Wi-Fi IP Camera
- Dimensions of NVR (L x W x H): 219*217*40(mm)
- Weight of Package: 9.9kg

What's Inside

NVR	1
Megapixel IP Camera	8
USB Mouse	1
Power Supply DC12V/2A	1
Power Supply DC12V/0.5A	8
User Manual	1
1m Net Cable	1
2TB hard disk (Optional)	1

WiFi 2MP H.265+



Model: WIFI3608DE6SW200/WIFI3608DED6SW200

Specification

- Camera Input: 6CH 1080P@15fps Wi-Fi IP Camera (Max. 9CH Input)
- IP Camera LBH30SW200W: 2MP Hisilicon, Outdoor Metal Bullet Case,
- 25m Night Vision, Support Wi-Fi
- Video Output: 1xHD Output/ 1xVGA Output
- Compression Method: H.265/H.265+, H.264/H.264+
- Recording Resolution: 1920*1080
- Wi-Fi Range: No Obstacles 350m Max.
- Network Interface: 1xRJ45 (10M/100M Adaptive Ethernet Interface)
- Preview Resolution: 4CH@1080P; 9CH@D1
- Playback Resolution: 4CH@1080P
- Hexaplex Operation Simultaneously: Preview, Recording, Playback, Live, Backup
- Static, Dynamic IP and DDNS, P2P, Wi-Fi, Support IE and Special Client Software
- Backup: 1xUSB2.0 (such as U Disk, USB Drive) and Network
- Support Remote View by Smart Phone
- Power Adaptor: 1xDC12V2A for Wi-Fi NVR, 2xDC12V0.5A for Wi-Fi IP Camera
- Dimensions of NVR (L x W x H): 260*215*43(mm)
- Weight of Package: 9.9kg

What's Inside

NVR	1
Megapixel IP Camera	6
USB Mouse	1
Power Supply DC12V/2A	1
Power Supply DC12V/0.5A	6
User Manual	1
1m Net Cable	1
2TB hard disk (Optional)	1

WiFi 2MP H.265+



Model: WIFI3608DE8SW200/WIFI3608DED8SW200

Specification

- Camera Input: 8CH 1080P@15fps Wi-Fi IP Camera (Max. 9CH Input)
- IP Camera LBH30SW200W: 2MP Hisilicon, Outdoor Metal Bullet Case,
- 25m Night Vision, Support Wi-Fi
- Video Output: 1xHD Output/ 1xVGA Output
- Compression Method: H.265/H.265+, H.264/H.264+
- Recording Resolution: 1920*1080
- Wi-Fi Range: No Obstacles 350m Max.
- Network Interface: 1xRJ45 (10M/100M Adaptive Ethernet Interface)
- Preview Resolution: 4CH@1080P; 9CH@D1
- Playback Resolution: 4CH@1080P
- Hexaplex Operation Simultaneously: Preview, Recording, Playback, Live, Backup
- Static, Dynamic IP and DDNS, P2P, Wi-Fi, Support IE and Special Client Software
- Backup: 1xUSB2.0 (such as U Disk, USB Drive) and Network
- Support Remote View by Smart Phone
- Power Adaptor: 1xDC12V2A for Wi-Fi NVR, 8xDC12V0.5A for Wi-Fi IP Camera
- Dimensions of NVR (L x W x H): 260*215*43(mm)
- Weight of Package: 9.9kg

What's Inside

NVR	1
Megapixel IP Camera	8
USB Mouse	1
Power Supply DC12V/2A	1
Power Supply DC12V/0.5A	8
User Manual	1
1m Net Cable	1
2TB hard disk (Optional)	1

4CH/8CH H.265+ PoE NVR Kits

2MP 5MP H.265+ PoE  Plug and Play



NVR3604DP3SF200
NVR3604DP3SS500

NVR3604DP2SF200
NVR3604DP2SS500

NVR3604DP1SF200
NVR3604DP1SS500



NVR Specification

- IP Camera Input: 9CH (5M/4M/3M/2M/1M, etc)
- POE: 4xIndependent 100Mbps PoE Network Interfaces (Total Power Output \geq 50W)
- Incoming Bandwidth: 60Mb
- Compression Method: H.265/H.265+, H.264/H.264+
- Recording Resolution: 5M/4M/3M/1080P/960P/720P, etc (All Real Time)
- Preview Resolution: Multi-channels@Main Stream/Sub-Stream
- Playback Resolution: 1CH@5M/4CH@1080P
- Hexaplex Operation Simultaneously: Preview, Recording, Playback, Live, Backup
- HD Output/VGA Output: 1920x1080/1280x1024/1280x720
- Audio Input/Output: 1CH RCA Input/1CH RCA Output
- Network Interface: 5xRJ-45 10/100Mbps Self-adaptive Ethernet Interfaces
- Backup: 2xUSB2.0
- 1 SATA Hard Disk Interface (2.5"/3.5" SATA, Up to 6TB)
- Support Remote View by Smart Phone, Support Plug and Play
- Power Adaptor: DC52V/1.25A
- Dimensions Package (LxWxH): 395*245*275(mm)
- Weight: 7.8kg

What's Inside

POE NVR	1
POE Camera	4
USB Mouse	1
20M Cat5e	4
User Manual	1
DC52V/1.25A	1
2TB hard disk (Optional)	1

4CH/8CH H.265+ PoE NVR Kits

4K H.265+ PoE  Plug and Play



NVR3604CDP3FE800
NVR3604CDP3S800

NVR3604CDP2FE800
NVR3604CDP2S800

NVR3604CDP1FE800
NVR3604CDP1S800



NVR Specification

- Solution: HISILICON Hi3536C
- IP Camera Input: 16CH (8MP/6MP/5MP/4MP/3MP/2MP/1MP, etc)
- POE: 4 x Independent 100Mbps PoE Network Interfaces (Total Power Output \geq 50W)
- Incoming Bandwidth: 120Mb; POE Income Bandwidth 60Mb
- Compression Method: H.265/H.265+, H.264/H.264+
- Recording Resolution: 4K/5M/4M/3M/1080P/960P/720p, etc (All Real Time)
- Preview Resolution: Multi-channels@Main Stream/Sub-Stream
- Playback Resolution: 1CH@4K/4CH@1080P
- Hexaplex Operation Simultaneously: Preview, Recording, Playback, Live, Backup
- HD Output/VGA Output: 4K (3840x2160)/1920x1080/1280x1024/1280x720
- Audio 1CH In/1CH Out, Alarm 4CH In/1CH Out
- Network Interface: 1xRJ-45 10/100/1000Mbps Self-adaptive Ethernet Interfaces
- Backup: 2xUSB2.0
- 1 SATA Hard Disk Interface (2.5"/3.5" SATA, Up to 6TB)
- Support Remote View by Smart Phone, Support Plug and Play
- Power Adaptor: DC52V/1.25A
- Dimensions Package (LxWxH): 395*245*275(mm)
- Weight: 6.8kg

What's Inside

POE NVR	1
POE Camera	4
USB Mouse	1
20M Cat5e	4
User Manual	1
DC52V/1.25A	1
2TB hard disk (Optional)	1

2MP 5MP H.265+ PoE  Plug and Play



NVR3608DP3SF200
NVR3608DP3SS500

NVR3608DP2SF200
NVR3608DP2SS500

NVR3608DP1SF200
NVR3608DP1SS500



NVR Specification

- IP Camera Input: 9CH (5MP/4MP/3MP/2MP/1MP, etc)
- POE: 8xIndependent 100Mbps PoE Network Interfaces (Total Power Output \geq 100W)
- Incoming Bandwidth: 60Mb
- Compression Method: H.265/H.265+, H.264/H.264+
- Recording Resolution: 5M/4M/3M/1080P/960P/720p, etc (All Real Time)
- Preview Resolution: Multi-channels@Main Stream/Sub-stream
- Playback Resolution: 1CH@5M/4CH@1080P
- Hexaplex Operation Simultaneously: Preview, Recording, Playback, Live, Backup
- HD Output/VGA Output: 1920x1080/1280x1024/1280x720
- Audio Output: 1CH 3.5mm Headphone Socket
- Network Interface: 9xRJ-45 10/100Mbps Self-adaptive Ethernet Interfaces
- Backup: 2xUSB2.0
- 1 SATA Hard Disk Interface (2.5"/3.5" SATA, Up to 8TB)
- Support Remote View by Smart Phone, Support Plug and Play
- Power Input: DC52V/1.25A
- Dimensions (LxWxH): 405*245*145(mm)
- Weight: 12.8kg

What's Inside

POE NVR	1
POE Camera	8
USB Mouse	1
20M Cat5e	8
User Manual	1
DC52V/1.25A	1
2TB hard disk (Optional)	1

4K H.265+ PoE  Plug and Play



NVR3608CDP3FE800
NVR3608CDP3S800

NVR3608CDP2FE800
NVR3608CDP2S800

NVR3608CDP1FE800
NVR3608CDP1S800



NVR Specification

- Solution: HISILICON Hi3536D
- IP Camera Input: 16CH (8MP/6MP/5MP/4MP/3MP/2MP/1MP, etc)
- POE: 8 x Independent 100Mbps PoE Network Interfaces (Total Power Output \geq 100W)
- Incoming Bandwidth: 120Mb; POE Income Bandwidth 60Mb
- Compression Method: H.265/H.265+, H.264/H.264+
- Recording Resolution: 4K/5M/4M/3M/1080P/960P/720p, etc (All Real Time)
- Preview Resolution: Multi-channels@Main Stream/Sub-stream
- Playback Resolution: 1CH@4K/4CH@1080P
- Hexaplex Operation Simultaneously: Preview, Recording, Playback, Live, Backup
- HD Output/VGA Output: 4K (3840x2160)/1920x1080/1280x1024/1280x720
- Audio 1CH In/1CH Out, Alarm 4CH In/1CH Out
- Network Interface: 1xRJ-45 10/100/1000Mbps Self-adaptive Ethernet Interfaces
- Backup: 2xUSB2.0
- 1 SATA Hard Disk Interface (2.5"/3.5" SATA, Up to 8TB)
- Support Remote View by Smart Phone, Support Plug and Play
- Power Input: DC52V/2.5A
- Dimensions (LxWxH): 310*295*46(mm)
- Weight: 12.8kg

What's Inside

POE NVR	1
POE Camera	8
USB Mouse	1
20M Cat5e	8
User Manual	1
DC52V/1.25A	1
2TB hard disk (Optional)	1

2MP 4CH XVR Kits

2MP Plastic



XVRDA2004D4PH200

XVRDA2004D4PB200

XVRDA2004D4PD200

Specification

- Chipset HI3520DV400, H.265/H.264
- BNC Video in 4CH : 5M@12fps, 4M@15fps, 3M@18fps, 2M@30fps
- IPC Video in 2CH (only IP up to 6ch), MAX 5MP
- Recording: 5M-N@8fps/4M-N@15fps/ 3M-N@18fps/2M-N@18fps
- Playback: 4 CH HD/ 4CH IPC : 2*1080P/1*5M
- AI Management: AI detection/ Face Comparison: 1CH
- 1xRJ45, 2xUSB, 1xRS485, 4xBNC, 1xHD, 1xVGA
- Audio 1ch In & 1ch Out; No Alarm
- 1xSATA (2.5"/ 3.5" SATA, Up to 6TB)
- DC12V/5A
- Weight of Kit Packag: 7.9kgs

What's Inside

XVR	1
HD Camera	4
18m Coaxial Cable	4
DC12V5A Adaptor	1
5CH Power Splitter Cable	1
2TB hard disk (Optional)	1



2MP Metal



XVRDA2004D4MH200

XVRDA2004D4MB200

XVRDA2004D4MD200

Specification

- Chipset HI3520DV400, H.265/H.264
- BNC Video in 4CH : 5M@12fps, 4M@15fps, 3M@18fps, 2M@30fps
- IPC Video in 2CH (only IP up to 6ch), MAX 5MP
- Recording: 5M-N@8fps/4M-N@15fps/ 3M-N@18fps/2M-N@18fps
- Playback: 4 CH HD/ 4CH IPC : 2*1080P/1*5M
- AI Management: AI detection/ Face Comparison: 1CH
- 1xRJ45, 2xUSB, 1xRS485, 4xBNC, 1xHD, 1xVGA
- Audio 1ch In & 1ch Out; No Alarm
- 1xSATA (2.5"/ 3.5" SATA, Up to 6TB)
- DC12V/5A
- Weight of Kit Packag: 7.9kgs

What's Inside

XVR	1
HD Camera	4
18m Coaxial Cable	4
DC12V3A Adaptor	1
5CH Power Splitter Cable	1
2TB hard disk (Optional)	1



5MP 4CH XVR Kits

5MP Plastic



XVRDA2004HD4PH500

XVRDA2004HD4PB500

XVRDA2004HD4PD500

Specification

- Chipset HI3520DV400, H.265 + /H.265/H.264 + /H.264
- BNC Video in 4CH : 4K@15fps, 5M@20fp, 4M@30fps, 3M@30fps/18fps, 2M@30fps
- IPC Video in 2CH (only IP up to 16ch), MAX 5MP
- Recording: 4K-N@8fps/ 5M-N@10fps/ 5M@6fps / 4M-N@15fps/ 4M@8fps/ 3M-N@18fps / 3M@9fps/ 2M-N@15fps
- Playback: 4 CH HD/ 4CH IPC : 4*5M@6fps/1*5M@30fps
- AI Management: AI detection/ Face Comparison: 1CH
- 1xCVBS, 1xRJ45, 2xUSB, 1xRS485, 4xBNC, 1xHD, 1xVGA
- Audio 2ch In & 1ch Out; Alarm 4ch In & 1ch Out
- 1xSATA (2.5"/ 3.5" SATA, Up to 6TB)
- DC12V5A
- DVR Dimension (L x W x H): 260*215*43(mm)
- Weight of Kit Package: 7.9kgs

What's Inside

XVR	1
HD Camera	4
18m Coaxial Cable	4
DC12V5A Adaptor	1
5CH Power Splitter Cable	1
2TB hard disk (Optional)	1



5MP Metal



XVRDA2004HD4MH500

XVRDA2004HD4MB500

XVRDA2004HD4MD500

Specification

- Chipset HI3520DV400, H.265 + /H.265/H.264 + /H.264
- BNC Video in 4CH : 4K@15fps, 5M@20fp, 4M@30fps, 3M@30fps/18fps, 2M@30fps
- IPC Video in 2CH (only IP up to 16ch), MAX 5MP
- Recording: 4K-N@8fps/ 5M-N@10fps/ 5M@6fps / 4M-N@15fps/ 4M@8fps/ 3M-N@18fps / 3M@9fps/ 2M-N@15fps
- Playback: 4 CH HD/ 4CH IPC : 4*5M@6fps/1*5M@30fps
- AI Management: AI detection/ Face Comparison: 1CH
- 1xCVBS, 1xRJ45, 2xUSB, 1xRS485, 4xBNC, 1xHD, 1xVGA
- Audio 2ch In & 1ch Out; Alarm 4ch In & 1ch Out
- 1xSATA (2.5"/ 3.5" SATA, Up to 6TB)
- DC12V5A
- DVR Dimension (L x W x H): 260*215*43(mm)
- Weight of Kit Package: 7.9kgs

What's Inside

XVR	1
HD Camera	4
18m Coaxial Cable	4
DC12V3A Adaptor	1
5CH Power Splitter Cable	1
2TB hard disk (Optional)	1



4K 4CH XVR Kits

4K Metal



XVRDA2104D4MH800



XVRDA2104D4MB800



XVRDA2104D4MB800



Specification

- Chipset HI3521D, H.265+/H.265/H.264+/H.264
- BNC Video in 4CH : 4K@15fps, 5M@20fps, 4M@30fps, 3M@30fps, 2M@30fps
- IPC Video in 4CH (only IP up to 16ch), MAX 8MP
- Recording: 4K-N@15fps/4K@8fps/ 5M@12fps/ 4M@15fps/ 3M@18fps/ 1080P/720P@30fps;
- Playback: 4CH HD/ 4CH IPC : 4*1080P/2*5M/1*8M
- 1xCVBS, 1xRJ45, 2xUSB, 1xRS485, 4xBNC, 1xHD, 1xVGA
- Audio 4ch In & 1ch Out; Without Alarm
- 1xSATA (2.5"/ 3.5" SATA, Up to 6TB)
- DC12V5A
- DVR Dimension (L×W×H): 260*215*43(mm)
- Weight of Kit Package: 7.9kgs

What's Inside

XVR	1
HD Camera	4
18m Coaxial Cable	4
DC12V3A Adaptor	1
5CH Power Splitter Cable	1
2TB hard disk (Optional)	1

2MP 8CH XVR Kits

2MP Plastic



XVRDA2008D8MH200



XVRDA2008D8MB200



XVRDA2008D8MD200



Specification

- Chipset HI3520DV400, H.265+/H.265/H.264+/H.264
- BNC Video in 8CH : 5M@12fps, 4M@15fps, 3M@18fps, 2M@30fps
- IPC Video in 2CH (only IP up to 16ch), MAX 5MP
- Recording: 5M-N@6fps/4M-N@8fps/ 3M-N@10fps/ 2M-N@15fps
- Playback: 8 CH HD/ 4CH IPC : 2*1080P/1*5M
- AI Management: AI detection/ Face Comparison: 1CH
- 1xCVBS, 1xRJ45, 2xUSB, 1xRS485, 8xBNC, 1xHD, 1xVGA
- Audio 2ch In & 1ch Out; Alarm 4ch In & 1ch Out
- 1xSATA (2.5"/ 3.5" SATA, Up to 6TB)
- DC12V2A & DC12V5A
- Weight of Kit Package: 10.3kgs

What's Inside

8CH XVR	1
HD Camera	8
8 x 18m Coaxial Cable	8
1 x DC12V2A Adaptor	1
1 x DC12V5A Adaptor	1
1 x 8CH Power Splitter Cable	1
2TB hard disk (Optional)	1

2MP 8CH XVR Kits

2MP Metal



XVRDA2008D8MH200



XVRDA2008D8MB200



XVRDA2008D8MD200



Specification

- Chipset HI3520DV400, H.265+/H.265/H.264+/H.264
- BNC Video in 8CH : 5M@12fps, 4M@15fps, 3M@18fps, 2M@30fps
- IPC Video in 2CH (only IP up to 16ch), MAX 5MP
- Recording: 5M-N@6fps/4M-N@8fps/ 3M-N@10fps/ 2M-N@15fps
- Playback: 8 CH HD/ 4CH IPC : 2*1080P/1*5M
- AI Management: AI detection/ Face Comparison: 1CH
- 1xCVBS, 1xRJ45, 2xUSB, 1xRS485, 8xBNC, 1xHD, 1xVGA
- Audio 2ch In & 1ch Out; Alarm 4ch In & 1ch Out
- 1xSATA (2.5"/ 3.5" SATA, Up to 6TB)
- DC12V2A & DC12V5A
- Weight of Kit Package: 10.3kgs

What's Inside

8CH XVR	1
HD Camera	8
8 x 18m Coaxial Cable	8
1 x DC12V2A Adaptor	1
1 x DC12V5A Adaptor	1
1 x 8CH Power Splitter Cable	1
2TB hard disk (Optional)	1

5MP 8CH XVR Kits

5MP Plastic



XVRDA2004HD4PH500



XVRDA2004HD4PB500



XVRDA2004HD4PD500



Specification

- Chipset HI3520DV100, H.265+/H.265/H.264+/H.264
- BNC Video in 8CH : 4K@15fps, 5M@20fps, 4M@30fps, 3M@30fps, 2M@30fps
- IPC Video in 2CH (only IP up to 16ch), MAX 5MP
- Recording: 4K-N@8fps/ 5M-N@10fps/ 5M@6fps/4M-N@15fps/ 4M@8fps/ 3M-N@18fps/ 3M@9fps/ 2M-N@15fps
- Playback: 8 CH HD/ 4CH IPC : 2*1080P/1*5M
- AI Management: AI detection/ Face Comparison: 2CH
- 1xCVBS, 1xRJ45, 2xUSB, 1xRS485, 8xBNC, 1xHD, 1xVGA
- Audio 6ch In & 1ch Out; Alarm 4ch In & 1ch Out
- 1xSATA (2.5"/ 3.5" SATA, Up to 6TB)
- DC12V2A & DC12V5A
- DVR Dimension (L×W×H): 260*215*43(mm)
- Weight of Kit Package: 10.3kgs

What's Inside

8CH XVR	1
HD Camera	8
8 x 18m Coaxial Cable	8
1 x DC12V2A Adaptor	1
1 x DC12V5A Adaptor	1
1 x 8CH Power Splitter Cable	1
2TB hard disk (Optional)	1

5MP 8CH XVR Kits

5MP Metal



XVRDA2008D8MH200

XVRDA2008D8MB200

XVRDA2008D8MD200

Specification

- Chipset HI3520DV100, H.265+/H.265/H.264+/H.264
- BNC Video in 8CH: 4K@15fps, 5M@20fps, 4M@30fps, 3M@30fps/18fps, 2M@30fps
- IPC Video in 2CH (only IP up to 16ch), MAX 5MP
- Recording: 4K-N@8fps/ 5M-N@10fps/ 5M@6fps /4M-N@15fps/ 4M@8fps/ 3M-N@18fps/ 3M@9fps/ 2M-N@15fps
- Playback: 8 CH HD/ 4CH IPC : 2*1080P/1*5M
- AI Management: AI detection/ Face Comparison: 2CH
- 1xCVBS, 1xRJ45, 2xUSB, 1xRS485, 8xBNC, 1xHD, 1xVGA
- Audio 6ch In & 1ch Out; Alarm 4ch In & 1ch Out
- 1xSATA (2.5"/ 3.5" SATA, Up to 6TB)
- DC 12V2A & DC12V5A
- DVR Dimension (L×W×H): 260*215*43(mm)
- Weight of Kit Package: 10.3kgs

What's Inside

8CH XVR	1
HD Camera	8
8 x 18m Coaxial Cable	8
1 x DC12V2A Adaptor	1
1 x DC12V5A Adaptor	1
1 x 8CH Power Splitter Cable	1
2TB hard disk (Optional)	1



4K 8CH XVR Kits

4K Metal



XVRDA3108D8MH800

XVRDA3108D8MB800

XVRDA3108D8MD800

Specification

- Chipset HI3531D, H.265+/H.265/H.264+/H.264
- BNC Video in 8CH: 4K@15fps, 5M@20fps, 4M@30fps, 3M@30fps, 2M@30fps
- IPC Video in 8CH (only IP up to 16ch), MAX 8MP
- Recording: 4K-N@15fps/ 4K@8fps/ 5M@12fps/ 4M@15fps/ 3M@18fps/ 1080P/720P@30fps;
- Playback: 8CH HD/ 9CH IPC : 9*1080P/3*5M/4*4M/2*8M
- 1xCVBS, 1xRJ45, 2xUSB, 1xRS485, 4xBNC, 1xHD, 1xVGA
- Audio 4ch In & 1ch Out; No Alarm
- 1xSATA (2.5"/ 3.5" SATA, Up to 16TB)
- DC 12V2A & DC12V5A
- DVR Dimension (L×W×H): 260*215*43(mm)
- Weight of Kit Package: 10.3kgs

What's Inside

8CH XVR	1
HD Camera	8
8 x 18m Coaxial Cable	8
1 x DC12V2A Adaptor	1
1 x DC12V5A Adaptor	1
1 x 8CH Power Splitter Cable	1
2TB hard disk (Optional)	1



CCTV Accessories



POE Switch

- 4CH/8CH/16CH/24CH
- 10/100M/1000M switch
- POE IEEE 802.3af



Splitter Cable

- 5CH or 8CH Splitter
- POE Splitter



IPC Tester

- Support 1080P HD camera test and PTZ control/ONVIF/Analog camera test and PTZ control



Camera Bracket

- Ceiling or wall bracket
- Bullet or dome type



Camera Housing

- Plastic or Aluminum Alloy



CCTV Lens

- Varifocal or fixed lens
- 1.3MP-4K Lens



LAN CABLE

- UTP Category 5e Outdoor Cable
- UTP Category 6e Outdoor Cable



PTZ Control Keyboard

- 2D/3D Joystick
- For IP/HD PTZ



CCTV Cable

- CAT5E Net Cable
- DC + BNC or DC + BNC + RCA
- HD Cable 18M-30M



UTP Video Balun BNC Connector



Monitor

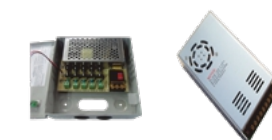

Power Box

- DC12V 5A-30A power supply
- 4/5/9/18 Electric Outputs



Power Adapter

- US, EU, UK, AU standard
- 500mA - 5000mA power current



LED Illuminator

- 80m/130m IR Distance
- 42 μ IR LEDs



HD Video Converter

